



1169	POLES, HARDWARE, AND FRAMING ANCHORING	
Sheet 1 of 1		
Rev: 07/01/20		

1169

ANCHORING

CONTAINS

- 1169-10 ANCHOR EXPANSION 10 IN WITH 3/4 IN ROD**
- 1169-20 ANCHOR PLATE 24IN WITH 1 IN ROD**
- 1169-30 ANCHOR HELIX, EXT, ADAPTER, HEAD**
- 1169-31 ANCHOR SINGLE HELIX**
- 1169-32 ANCHOR DOUBLE HELIX W/EXT & ADAPTER**
- 1169-33 ANCHOR TRIPLE HELIX W/EXT & ADAPTER**
- 1169-40 ANCHOR ROCK**

1169-10	POLES, HARDWARE, AND FRAMING ANCHORS ANCHOR EXPANSION 10 IN WITH 3/4 IN ROD (EXAMPLE: “BUST ANCHOR”)	
Sheet 1 of 2		
Rev: 07/01/20		

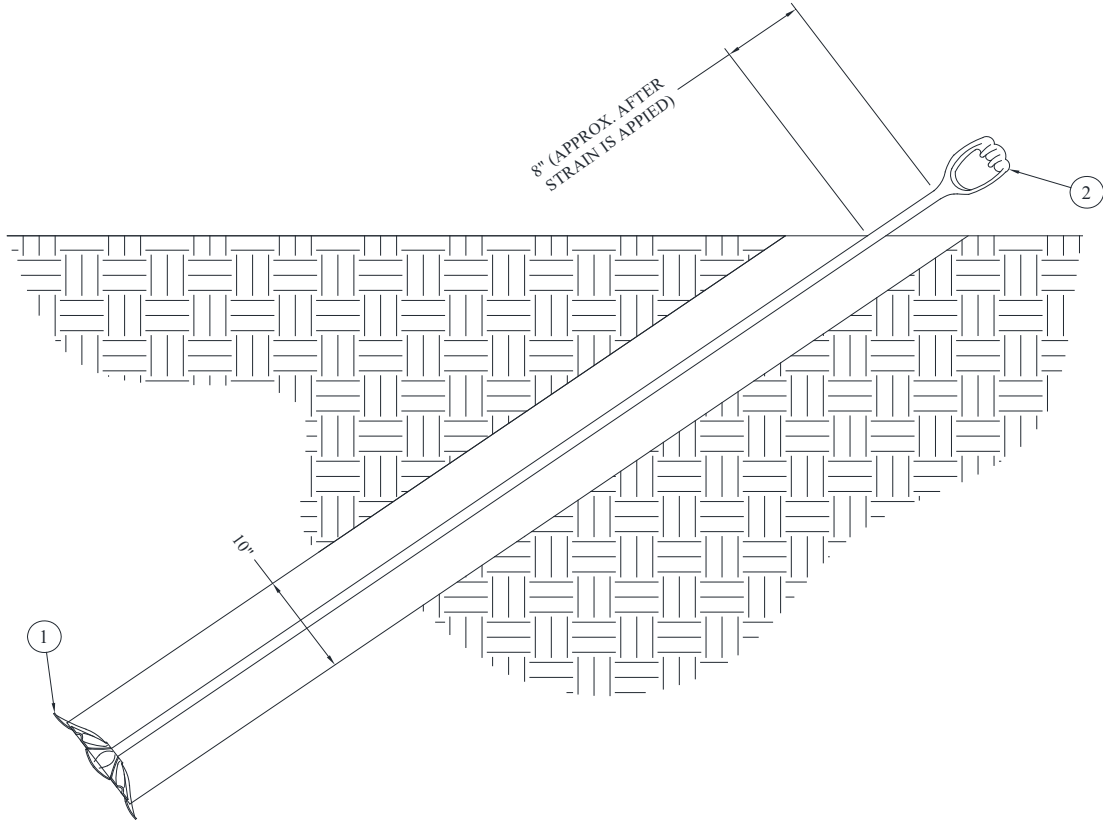

NOTES:

1. THE ANGLE OF THE HOLE WILL VARY WITH THE DISTANCE FROM THE POLE. THE HOLE SHALL BE DRILLED AT AN ANGLE SUCH THAT THE INSTALLED ANCHOR WILL POINT TO THE TOP OF THE POLE.
2. THE ANCHOR ROD SHALL NOT BE BENT DURING INSTALLATION.
3. DETERMINE LOCATION OF UNDERGROUND UTILITIES BEFORE DIGGING.
4. NEVER ATTACH PERSONAL PROTECTIVE GEAR TO GUYS OR ANCHOR RODS.
5. DIG A HOLE WITH A DIAMETER NO LARGER THAN THE UNEXPANDED ANCHOR. SIZE OF HOLE TO BE SAME AS UNEXPECTED ANCHOR.
6. INSERT ANCHOR AND ROD ASSEMBLY INTO THE HOLE. THEN POUND ON THE INNER EDGES OF THE ANCHOR PLATE UNTIL IT HAS FLATTENED OUT COMPLETELY. (PIPE, ANCHOR BUSTER, OR TAMP ARE RECOMMENDED.)
7. LENGTH AND ANGLE OF THE ANCHOR DETERMINES THE DEPTH OF THE HOLE. WHEN STRAIN IS APPLIED, THE EYE OF THE ROD SHOULD EXTEND APPROXIMATELY 8" ABOVE GROUND LEVEL TO PREVENT CORROSION OF GUY DEAD ENDS.
8. OUTER EDGES OF THE EXPANDED ANCHOR SHOULD PROTRUDE INTO UNDISTURBED SOIL.
9. COMPACT BACKFILL TO ORIGINAL CONDITION FOR PROPER INSTALLATION.
10. WHEN INSTALLING MULTIPLE ANCHORS, MAINTAIN AT LEAST 5'-0" OF SEPARATION BETWEEN ANCHORS.

1169-10-08

1169-10	POLES, HARDWARE, AND FRAMING ANCHORS ANCHOR EXPANSION 10 IN WITH 3/4 IN ROD (EXAMPLE: "BUST ANCHOR")	
Sheet 2 of 2		
Rev: 07/01/20		

CU

CU-ID	CU-REF	CU-DESCRIPTION
ANCEXP10INW3/4INX9FTROD	11691008	ANCHOR EXP 10 IN WITH 3/4 IN X 9 FT ROD

ID	PART NUM	PART DESC	QTY	EA	CU-REF
1	0000006504	ANCHOR EXPANDING GUY	1	EA	11691008
2	0000006523	ROD ANCHOR 3/4 IN X 9 FT TRIPLE EYE	1	EA	11691008

1169-20	POLES, HARDWARE, AND FRAMING ANCHORS ANCHOR PLATE 24 IN WITH 1 IN ROD (EXAMPLE: "TUBCO")	
Sheet 1 of 2		
Rev: 07/01/20		

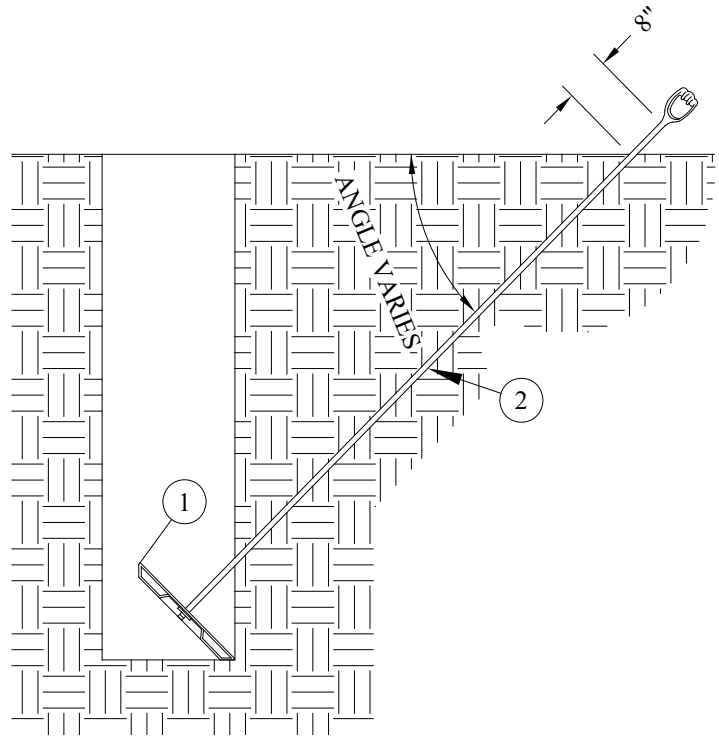
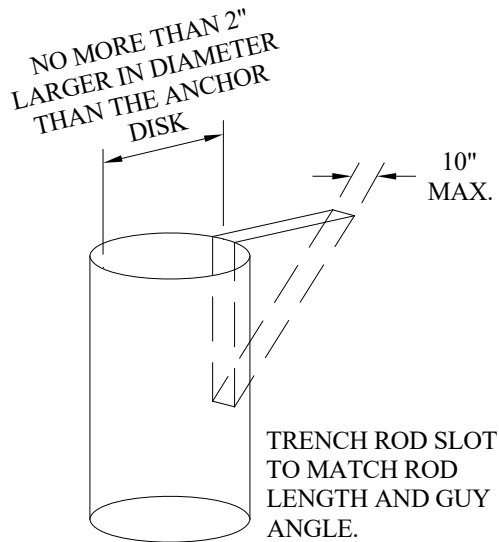

1169-20-24

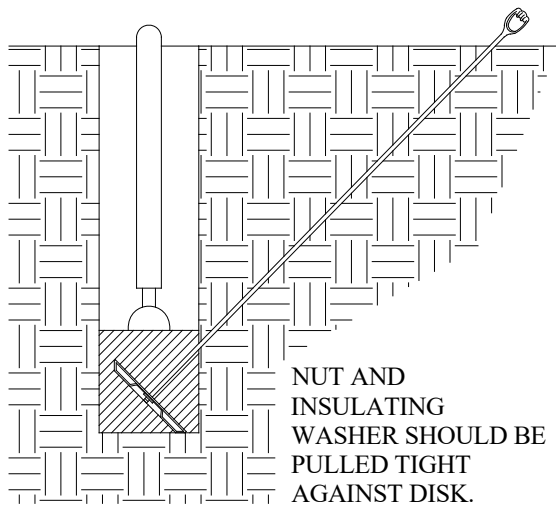

NOTES:

1. DRILL HOLE VERTICALLY NO MORE THAN 2" LARGER IN DIAMETER THAN THE ANCHOR DISK.
2. DIG THE TRENCH FOR ANCHOR ROD NO MORE THAN 10" WIDE. KEEP IN LINE WITH THE GUY ATTACHMENT LOCATION.
3. COVER DISK WITH EXCAVATION SPOILS UNTIL IT HAS BEEN PROPERLY INSTALLED AND ALIGNED. IF THE ROD IS BENT, THE INTEGRITY OF THE INSTALLATION WILL BE COMPROMISED.
4. COMPACT BACKFILL TO ORIGINAL CONDITION FOR PROPER INSTALLATION.

1169-20	POLES, HARDWARE, AND FRAMING ANCHORS ANCHOR PLATE 24 IN WITH 1 IN ROD (EXAMPLE: "TUBCO")	
Sheet 2 of 2		
Rev: 07/01/20		

CU

CU-ID	CU-REF	CU-DESCRIPTION
ANCPLT24INW1INX10FTROD	11692024	ANCHOR PLATE 24 IN WITH 1 IN X 10 FT ROD

ID	PART NUM	PART DESC	QTY	EA	CU-REF
1	0000006506	ANCHOR DISK 1 IN HOLE 24 IN ROUND	1	EA	11692024
2	0000006527	ROD ANCHOR 1 IN X 10 FT TRIPLE EYE PROTECTION	1	EA	11692024

1169-30
Sheet 1 of 2
Rev: 07/01/20

**POLES, HARDWARE, AND FRAMING
ANCHORS
ANCHOR HELIX, EXTENSION, ADAPTER HEAD**

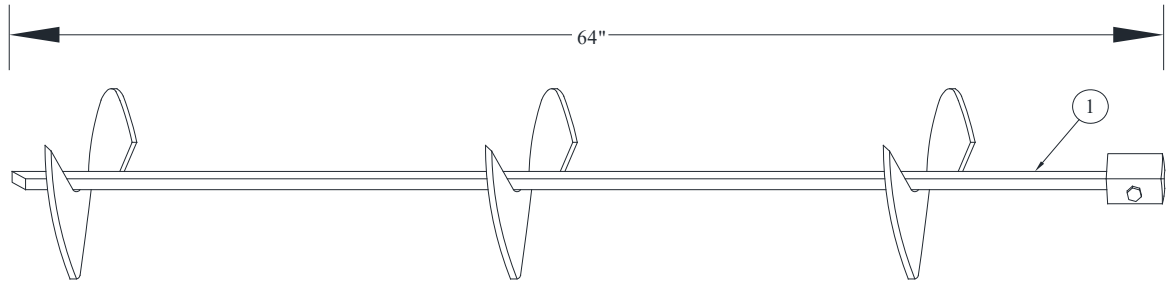

1169-30-01 ANCHOR TRIPLE HELIX 1-1/2"

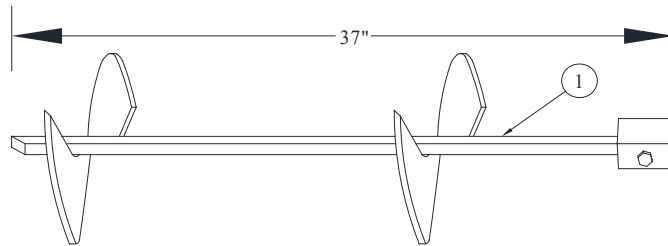

1169-30-02 ANCHOR DOUBLE HELIX 1-1/2"

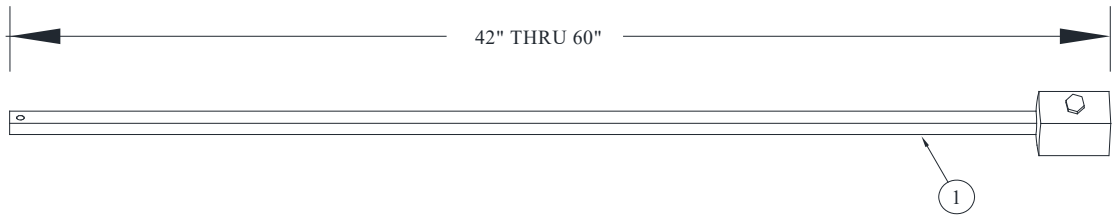

1169-30-11 ANCHOR EXTENSION 1-1/2" X 42"
1169-30-12 ANCHOR EXTENSION 1-1/2" X 60"

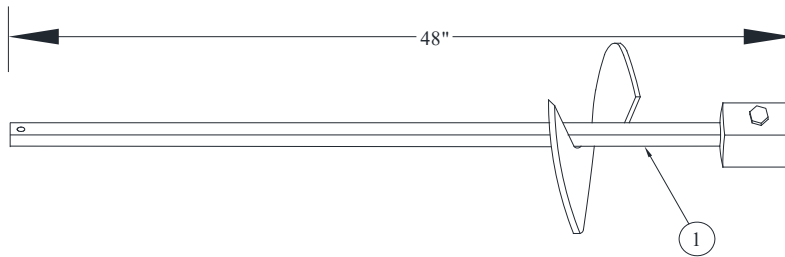

1169-30-17 ANCHOR EXTENSION SGL HELIX

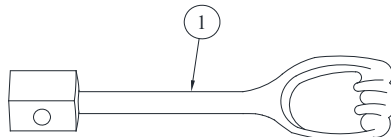

1169-30-21 ADAPTER HEAD 1-1/2" X 18"

1169-30	POLES, HARDWARE, AND FRAMING ANCHORS ANCHOR HELIX, EXTENSION, ADAPTER HEAD	
Sheet 2 of 2		
Rev: 07/01/20		

CU

CU-ID	CU-REF	CU-DESCRIPTION
--------------	---------------	-----------------------

ANCTPLHELIX1-1/2IN	11693001	ANCHOR TRIPLE HELIX 1-1/2 IN
--------------------	----------	------------------------------

ID	PART NUM	PART DESC	QTY		CU-REF
1	0000000643	ANCHOR TRPL 8-10-12 IN HLX 1-1/2IN SQ SHFT 7000 FT LBS	1	EA	11693001

ANCDBLHELIX1-1/2IN	11693002	ANCHOR DOUBLE HELIX 1-1/2 IN
--------------------	----------	------------------------------

ID	PART NUM	PART DESC	QTY		CU-REF
1	0000018709	ANCHOR DBL 8-10 IN HLX 1-1/2 IN SQ SHAFT 7,000 FT LBS	1	EA	11693002

ANCEXT1-1/2IN-3-1/2FT	11693011	HELIX EXTENSION 1-1/2 IN X 3-1/2 FT
-----------------------	----------	-------------------------------------

ID	PART NUM	PART DESC	QTY		CU-REF
1	0000000640	EXTENSION ANCHOR 1-1/2IN SQ SHFT 42IN LNGTH 7000 FT LBS	1	EA	11693011

ANCEXT1-1/2IN-5FT	11693012	HELIX EXTENSION 1-1/2 IN X 5 FT
-------------------	----------	---------------------------------

ID	PART NUM	PART DESC	QTY		CU-REF
1	0000000641	EXTENSION ANCHOR 1-1/2IN SQ SHFT 60IN LNGTH 7000 FT LBS	1	EA	11693012

ANCEXT1-3/4IN-4FT	11693017	HELIX EXTENSION 1-3/4IN SHAFT X 4FT
-------------------	----------	-------------------------------------

ANCEXT1-1/2-48IN	11693017	HELIX EXTENSION 1-1/2 IN X 48 IN
------------------	----------	----------------------------------

ID	PART NUM	PART DESC	QTY		CU-REF
1	0000015532	EXTENSION ANCHR W/1 14IN HLX 1-3/4IN SQ SHFT 48IN LNGTH	1	EA	11693017
1	0000018710	EXTENSION ANCHR W/1 14IN HLX 1-1/2IN SQ SHFT 48IN LNGTH	1	EA	11693017

ADPTANC3EYE1-1/2IN	11693021	ADAPTOR ANCHOR 3 EYE 1-1/2 IN
--------------------	----------	-------------------------------

ID	PART NUM	PART DESC	QTY		CU-REF
1	0000000642	ADAPTER ANCHOR TRIPLE EYE 1-1/2IN SQ SHFT 7000 FT LBS	1	EA	11693021

1169-31
Sheet 1 of 2
Rev: 07/01/20

POLES, HARDWARE, AND FRAMING
ANCHORS
ANCHOR SINGLE HELIX

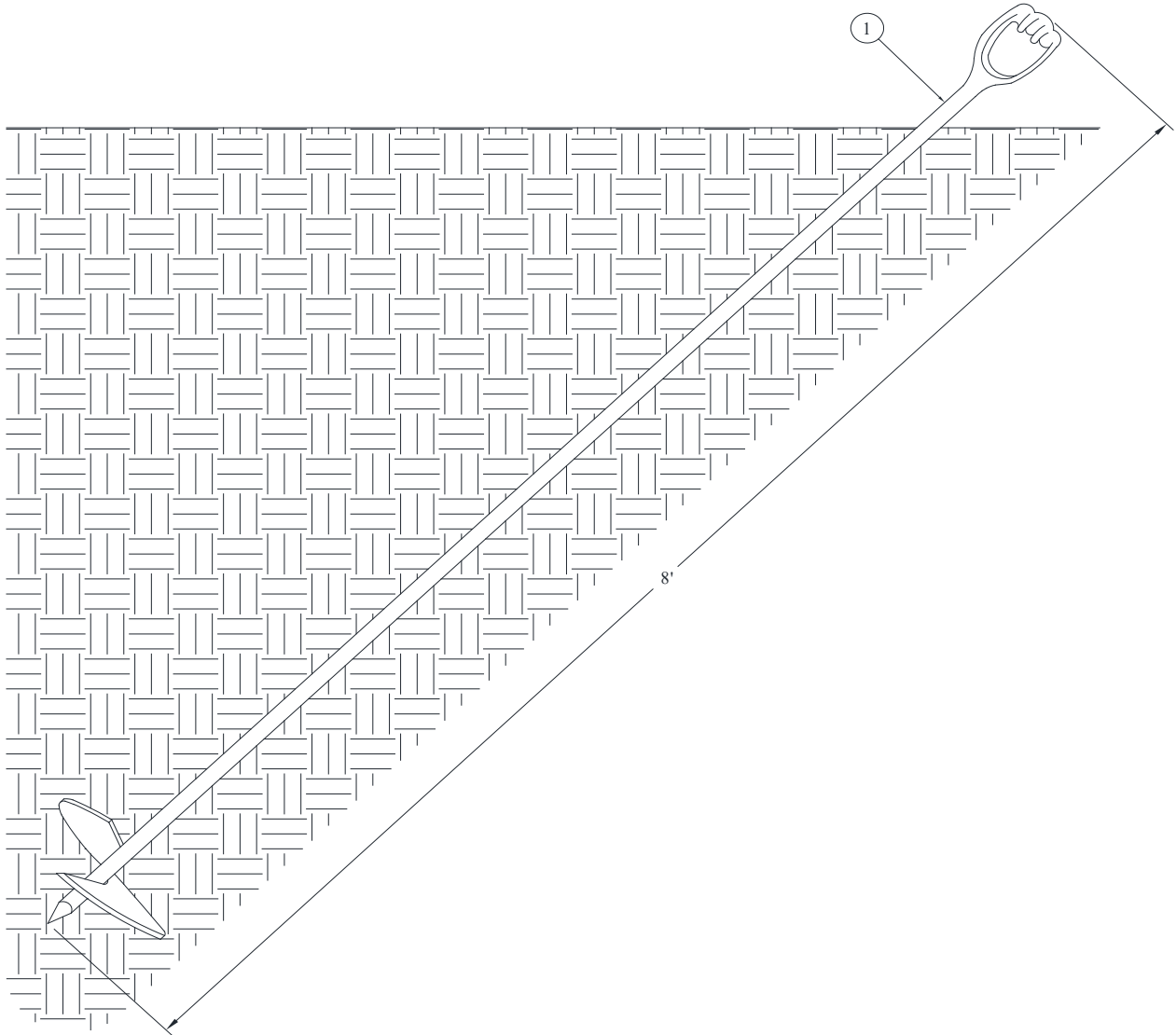

NOTES:

1. HELIX OR POWER-INSTALLED SCREW ANCHORS MUST ALWAYS BE INSTALLED AT ANGLE.
2. THE ENTIRE LENGTH MUST BE ALIGNED WITH THE GUY ATTACHMENT POINT ON THE POLE.
3. NEVER USE HEAD SECTION TO CORRECT THE ANGLE TO THE POLE FROM AN IMPROPERLY ALIGNED ANCHOR.

1169-31-02

1169-31	POLES, HARDWARE, AND FRAMING ANCHORS ANCHOR SINGLE HELIX	
Sheet 2 of 2		
Rev: 07/01/20		

CU

CU-ID	CU-REF	CU-DESCRIPTION
ANCSGLHELIX	11693101	ANCHOR SINGLE HELIX

ID	PART NUM	PART DESC	QTY	CU-REF
1	0000015467	ANCHOR SCREW-IN 10 INCH DISK 1-1/4 X 96 ROD W/ TRIPLEYE	1 EA	11693101

1169-32
Sheet 1 of 2
Rev: 07/01/20

POLES, HARDWARE, AND FRAMING
ANCHORS
ANCHOR DOUBLE HELIX WITH EXTENSION AND ADAPTER

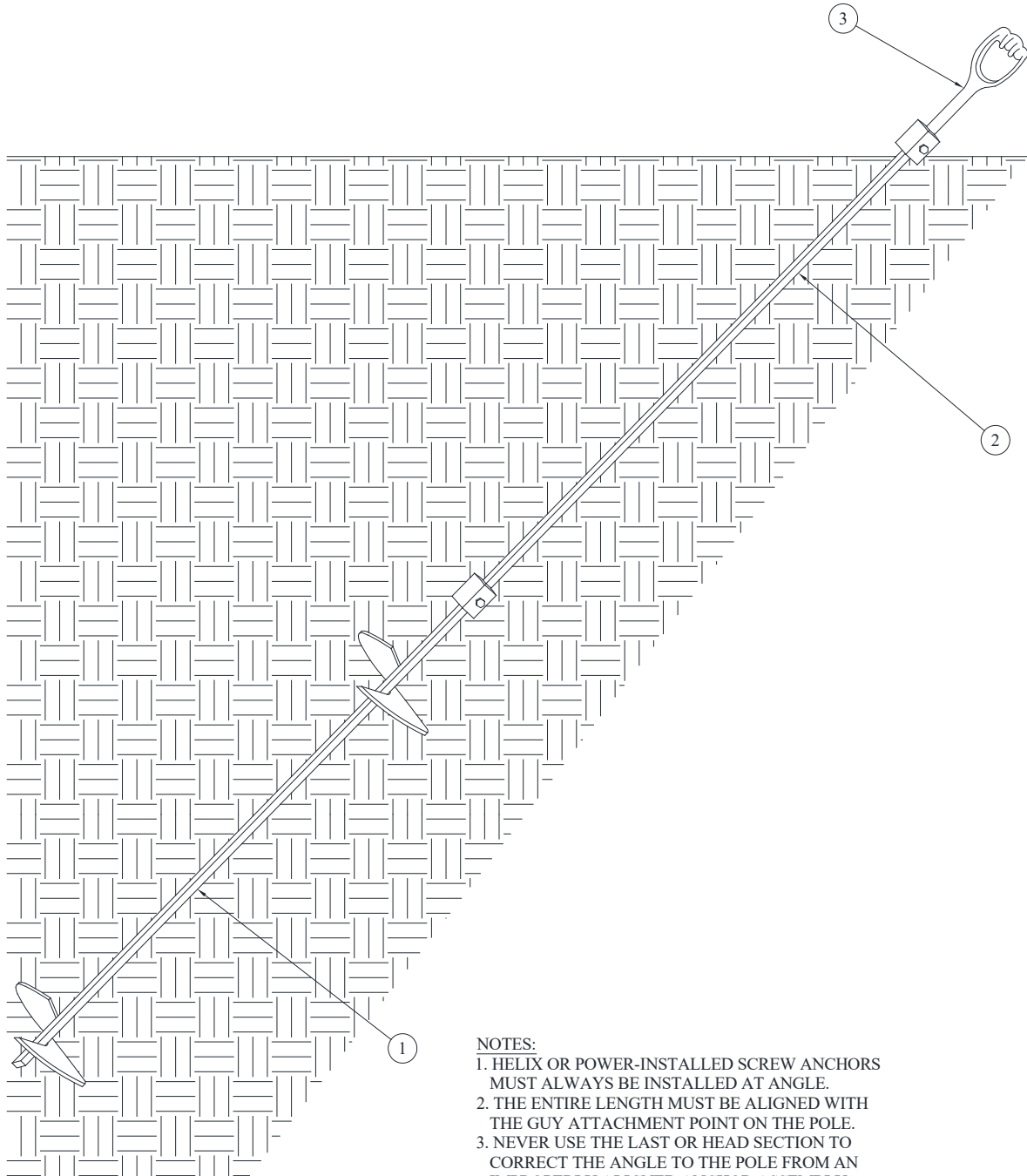

- NOTES:**
1. HELIX OR POWER-INSTALLED SCREW ANCHORS MUST ALWAYS BE INSTALLED AT ANGLE.
 2. THE ENTIRE LENGTH MUST BE ALIGNED WITH THE GUY ATTACHMENT POINT ON THE POLE.
 3. NEVER USE THE LAST OR HEAD SECTION TO CORRECT THE ANGLE TO THE POLE FROM AN IMPROPERLY ALIGNED ANCHOR ASSEMBLY.

1169-32-02

1169-32	POLES, HARDWARE, AND FRAMING ANCHORS ANCHOR DOUBLE HELIX WITH EXTENSION AND ADAPTER	
Sheet 2 of 2		
Rev: 07/01/20		

CU

CU-ID	CU-REF	CU-DESCRIPTION
ANCDBLHELIXEXTADAPT	11693202	ANCHOR DBL HELIX WITH EXTENSION/ADAPTER

ID	PART NUM	PART DESC	QTY	CU-REF
1	0000000654	ANCHOR DBL 8-10 IN HLX 1-3/4IN SQ SHAFT 10,000 FT LBS	1 EA	11693202
2	0000000655	EXTENSION ANCHOR 1-3/4IN SQ SHFT 37IN LNGTH 10K FT LBS	1 EA	11693202
3	0000000656	ADAPTER ANCHOR TRIPLE EYE 1-3/4IN SQ SHFT 10K FT LBS	1 EA	11693202

1169-33
Sheet 1 of 2
Rev: 07/01/20

POLES, HARDWARE, AND FRAMING
ANCHORS
ANCHOR TRIPLE HELIX W/EXTENSION AND ADAPTER

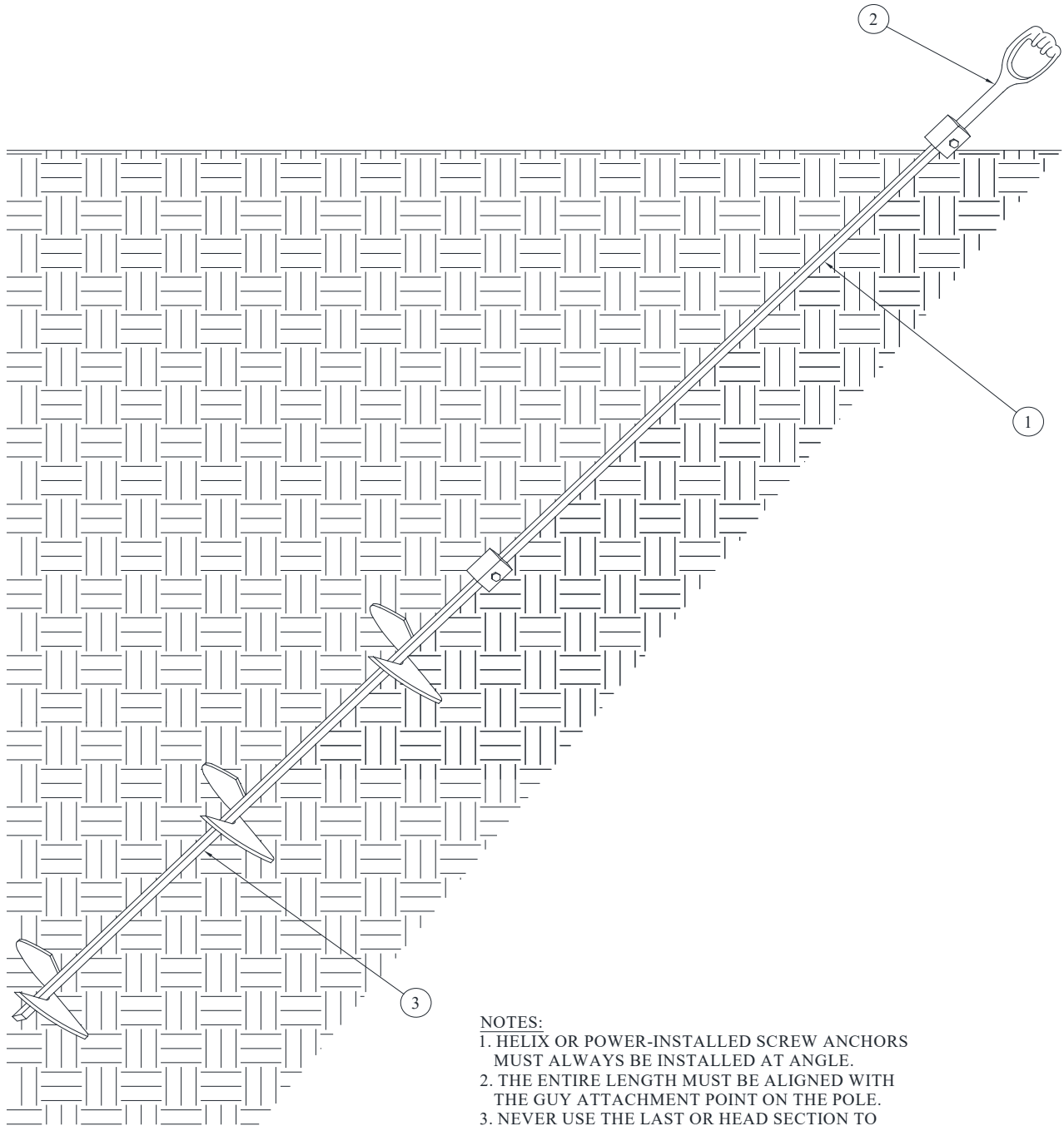

- NOTES:**
1. HELIX OR POWER-INSTALLED SCREW ANCHORS MUST ALWAYS BE INSTALLED AT ANGLE.
 2. THE ENTIRE LENGTH MUST BE ALIGNED WITH THE GUY ATTACHMENT POINT ON THE POLE.
 3. NEVER USE THE LAST OR HEAD SECTION TO CORRECT THE ANGLE TO THE POLE FROM AN IMPROPERLY ALIGNED ANCHOR ASSEMBLY.

1169-33-03

1169-33	POLES, HARDWARE, AND FRAMING ANCHORS ANCHOR TRIPLE HELIX W/EXTENSION AND ADAPTER	
Sheet 2 of 2		
Rev: 07/01/20		

CU

CU-ID	CU-REF	CU-DESCRIPTION
ANCTPLHELIXEXTADAPT	11693303	ANCHOR TPL HELIX WITH EXTENSION/ADAPTER

ID	PART NUM	PART DESC	QTY	EA	CU-REF
1	0000000641	EXTENSION ANCHOR 1- 1/2IN SQ SHFT 60IN LNGTH 7000 FT LBS	1	EA	11693303
2	0000000642	ADAPTER ANCHOR TRIPLE EYE 1-1/2IN SQ SHFT 7000 FT LBS	1	EA	11693303
3	0000000643	ANCHOR TRPL 8- 10- 12 IN HLX 1- 1/2IN SQ SHFT 7000 FT LBS	1	EA	11693303

1169-40	POLES, HARDWARE, AND FRAMING ANCHORS ANCHOR ROCK	
Sheet 1 of 2		
Rev: 07/01/20		

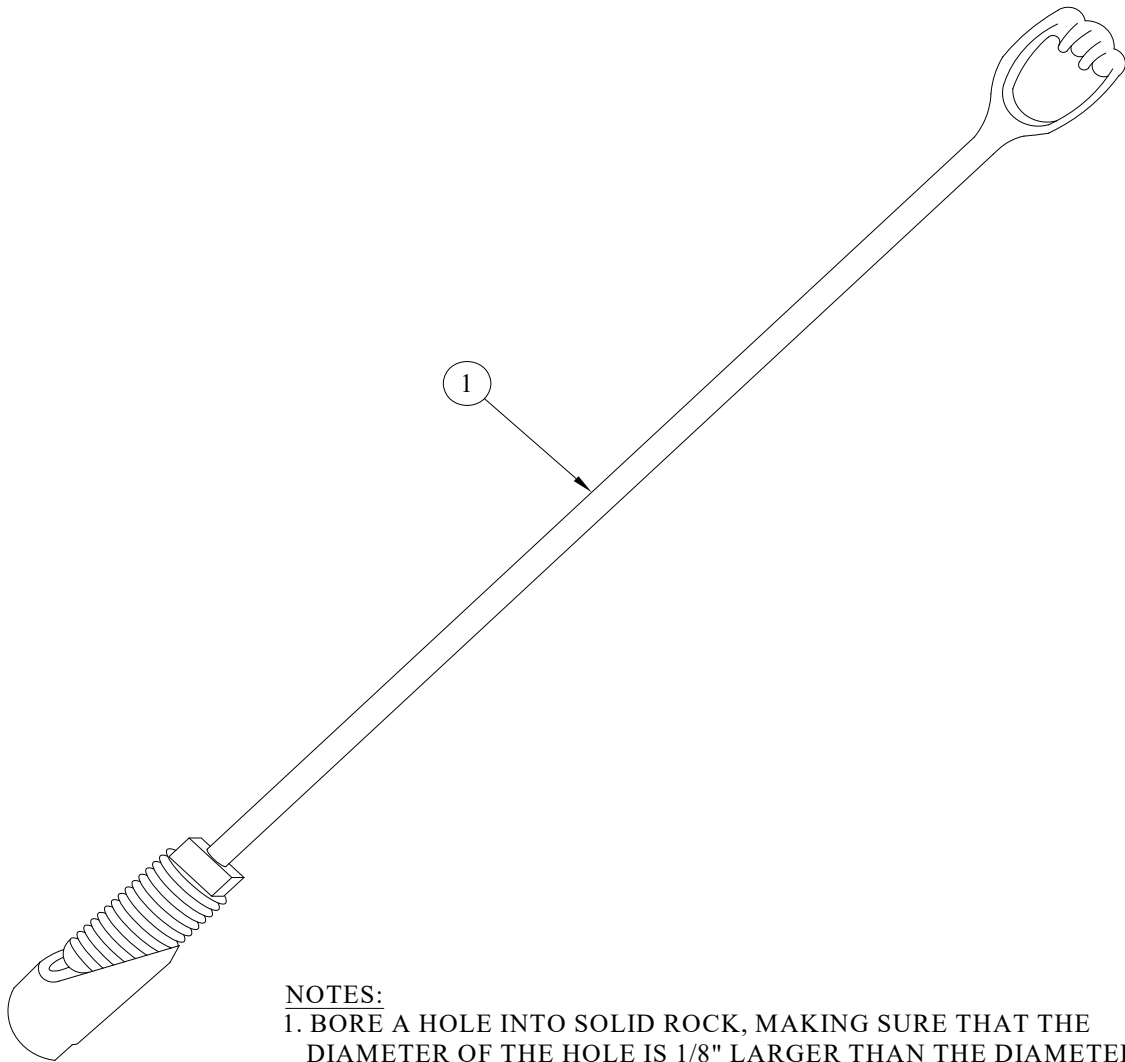

NOTES:

1. BORE A HOLE INTO SOLID ROCK, MAKING SURE THAT THE DIAMETER OF THE HOLE IS 1/8" LARGER THAN THE DIAMETER OF THE UNEXPANDED ANCHOR.
2. INSERT ANCHOR ASSEMBLY INTO THE HOLE.
3. PUT A BAR THROUGH THE LARGER EYE OF THE ANCHOR ROD.
4. TURN THE ROD UNTIL THE ANCHOR IS FIRMLY EXPANDED AGAINST THE SIDES OF THE HOLE.
5. FILL THE ROD HOLE TO GROUND LEVEL WITH GROUT.

1169-40-10 6' ROD
 1169-40-11 8' ROD

1169-40	POLES, HARDWARE, AND FRAMING ANCHORS ANCHOR ROCK	
Sheet 2 of 2		
Rev: 07/01/20		

CU

CU-ID	CU-REF	CU-DESCRIPTION
--------------	---------------	-----------------------

ANCRK1-3/4INW3/4INX6FTROD	11694010	ANCHOR ROCK 1-3/4 IN W/3/4IN X 72 IN ROD
---------------------------	----------	--

ID	PART NUM	PART DESC	QTY	EA	CU-REF
1	0000001196	ANCHOR EXPANDING ROCK 1-3/4 IN X 2-3/8 IN	1	EA	11694010

ANCRK1-3/4INW3/4INX8FTROD	11694011	ANCHOR ROCK 1-3/4 IN W/3/4IN X 96 IN ROD
---------------------------	----------	--

ID	PART NUM	PART DESC	QTY	EA	CU-REF
1	0000001842	ANCHOR XPNDN ROCK ROD DIA 3/4IN L 96IN ANCHOR 1-3/4IN	1	EA	11694011