

1438	CIVIL	
Sheet 1 of 1	PADS, CLEARANCES, AND BARRIERS	
Rev: 08/01/20		

1438

BARRIERS AND PADS

CONTAINS

1438-08	CLEARANCES FOR URD PADS ONLY
1438-10	BARRIERS & COMMERCIAL CLEARANCES
1438-12	SWITCHGEAR PAD 3PH PME-9
1438-14	SWITCHGEAR PAD 3PH PME-10
1438-16	SWITCHGEAR PAD 3PH PME-11
1438-17	SWITCHGEAR PAD 3PH PME-12
1438-22	PAD CIP SECTIONAL CAB 1, 2, & 3 CIRCUITS
1438-24	PAD CIP LOADBREAK SECTIONAL CABINET
1438-28	NOTES FOR VISTA PAD DETAILS
1438-31	VISTA 3 WAY 600 AND 900 AMP PAD DETAIL
1438-36	VISTA 4 WAY 600 AND 900 AMP PAD DETAIL
1438-41	VISTA 6 WAY 600 AND 900 AMP PAD DETAIL
1438-43	NOTES FOR PME ATO SWITCHGEAR PAD
1438-44	PAD PME ATO SWITCHGEAR
1438-46	NOTES FOR DBL TANK ATO SWITCHGEAR PAD
1438-47	PAD DBL TANK ATO SWITCHGEAR
1438-48	PAD PREFORMED TEMP XFMR (25-167KVA)
1438-55	NOTES FOR SINGLE & THREE PHASE XFMR PADS
1438-60	PAD CIP 1PH XFMR 5FT X 5FT (25-250KVA)
1438-90	PAD CIP 3PH XFMR 10FT X 10FT (75-2500KVA)
1438-95	15 INCH PAD FOR URD METER PEDESTAL
1438-96	METER PAD AND PEDESTAL ASSEMBLY
1438-97	PEDESTAL ASSEMBLIES POSITIONING

1438-08
Sheet 1 of 2
Rev: 08/01/20

CIVIL
PADS, CLEARANCES AND BARRIERS
CLEARANCES FOR URD PADS ONLY



1438

NOTE: ALL CLEARANCE MEASUREMENTS SHOWN BELOW ARE SUBJECT TO THE PARAMETERS FOR CLEARANCES ON PADS, SEE PAGE 1438-08A.

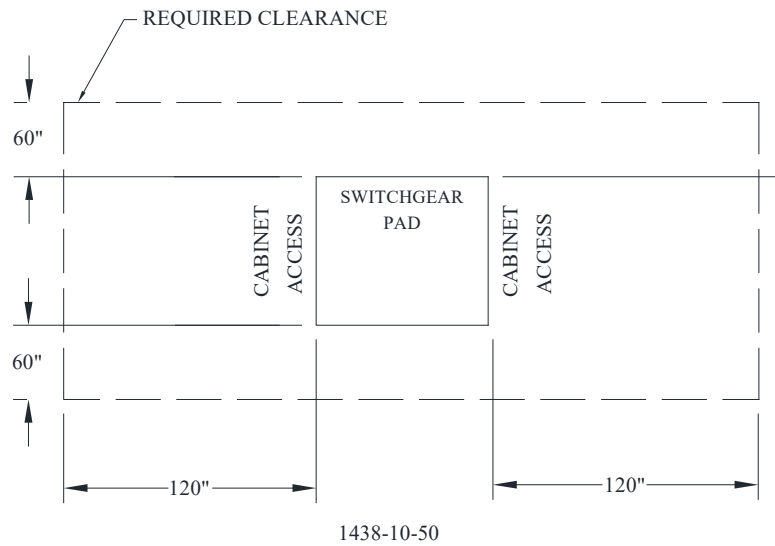
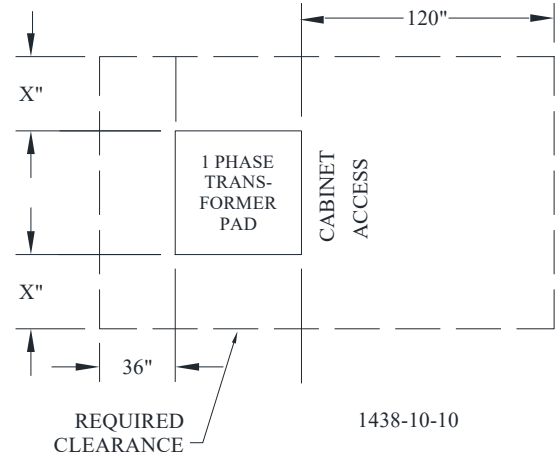
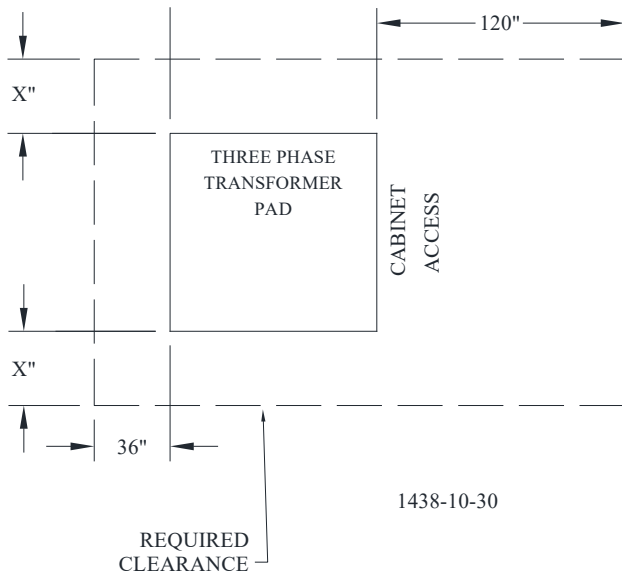

CLEARANCE MEASUREMENTS SHOWN ABOVE ARE STANDARD CLEARANCES FOR URD CABLE.

PER CITY ORDINANCE, THERE SHALL BE NO TREES, SHRUBBERY, FENCES ETC., WITHIN THE CLEARANCE AREA.

CONTACT AE DESIGN FOR ANY QUESTIONS REGARDING THE CLEARANCES.

1438-08A	CIVIL PADS, CLEARANCES AND BARRIERS PARAMETERS FOR CLEARANCES ON PADS	
Sheet 2 of 2		
Rev: 08/01/20		

Minimum clearances required for all pad-mount transformer pads (and other padmounted electrical equipment) applicable only to brick or masonry structures with minimum 2-hour fire rating except as noted.

1. Hot-Stick use area- 10 ft-open area or clearance to adjacent building or structure.
2. Sides without operators or controls- 3 ft-open area from any removable ventilated obstruction (fence).
3. Sides with operators or controls- 5 ft-open area from any removable ventilated obstruction (fence).
4. All sides- 20 ft-clearance from edge of oil filled equipment pad to fire escape.
5. Any side when pad is adjacent to brick or masonry building or structure- 5 ft-minimum horizontal clearance from side edges of equipment pad to building or structure.
6. Any side when pad is adjacent to brick or masonry building or structure- 5 ft-minimum lateral clearance from edge of pad for windows, doors, and ventilating ducts.
7. Any side when pad is adjacent to non brick or masonry building or structure- 12 ft-horizontal clearance from edge of oil filled equipment pad to non brick or masonry building or fixed structure.
8. Any side when pad is adjacent to windows, doors, or ventilating ducts- 12 ft-vertical clearance from grade for windows, doors, and ventilating ducts when lateral clearance is less than 5 ft from oil filled equipment pad.
9. Any side when pad is adjacent to windows, doors, or ventilating ducts- 12 ft-horizontal clearance from edge of oil filled equipment pad to building or fixed structure, if a window, door, or ventilating duct is less than 12 ft from grade or less than 5 ft of lateral separation.
10. Vertical clearance above the pad and the total minimum clearance area surrounding the pad - NO COVERING, BUILDING, OR STRUCTURE OF ANY KIND IS ALLOWED DIRECTLY ABOVE THE PAD OR THE MINIMUM EQUIPMENT AREA ASSOCIATED WITH THE PAD.

Contact AE Design for any questions regarding the above.

1438-10
Sheet 1 of 2
Rev: 08/01/20

CIVIL
PADS, CLEARANCES AND BARRIERS
BARRIER POSTS AND COMMERCIAL CLEARANCES

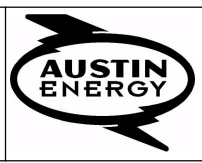

INSTALL BARRIER POSTS WHENEVER PAD MOUNTED EQUIPMENT IS INSTALLED WITHIN 4 FT OF A TRAFFIC AREA. DISTANCE BETWEEN POSTS SHOULD NOT EXCEED 4 FT. WALLS MAY NOT REPLACE BARRIER POSTS.

A 12 FT WIDE ACCESS DRIVE IS REQUIRED FOR MOST TRANSFORMER AND SWITCHGEAR INSTALLATIONS.

EQUIPMENT PADS MUST BE PLACED OUTSIDE OF ANY HAZARDOUS LOCATIONS WHERE GASOLINE OR OTHER FLAMMABLE LIQUIDS ARE STORED AS DEFINED IN ARTICLE 514 OF THE NATIONAL ELECTRIC CODE.

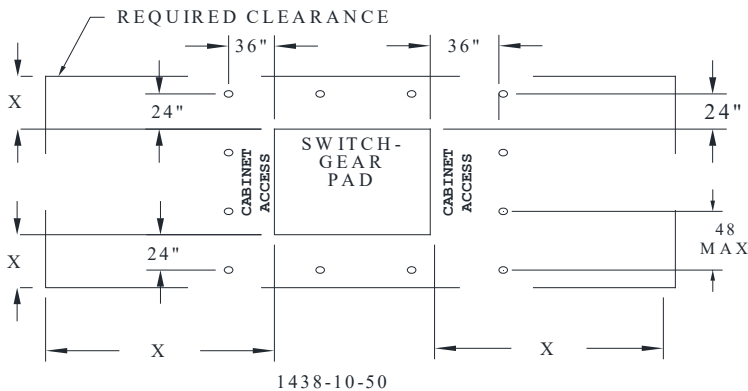
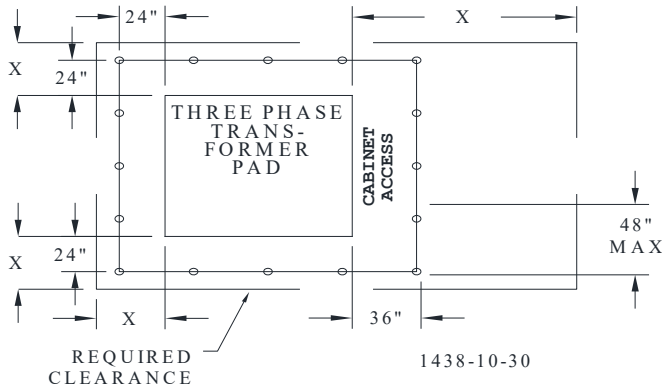
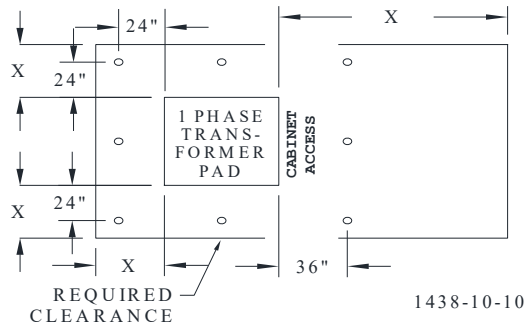
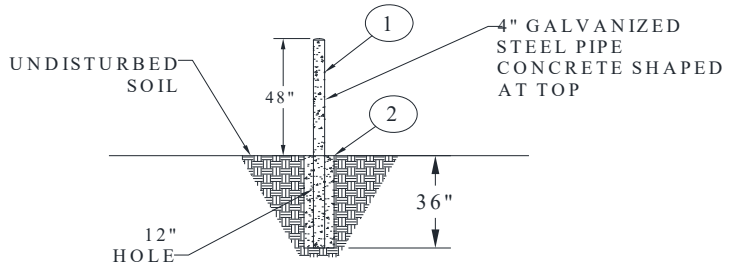

1438-12
Sheet 1 of 2
Rev: 08/01/20

CIVIL
PADS, CLEARANCES AND BARRIERS
SWITCHGEAR PAD 3PH PME-9

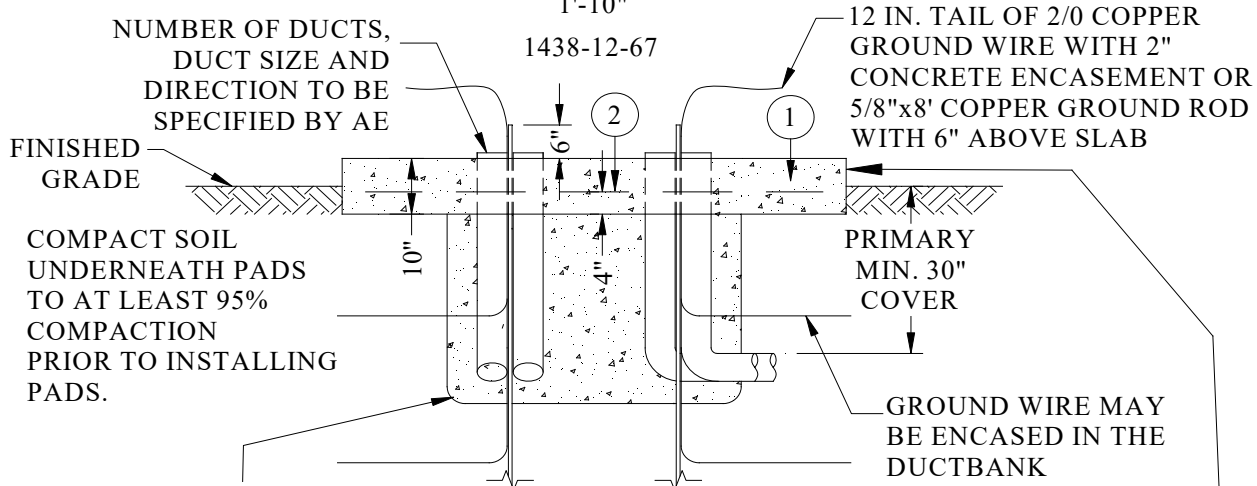
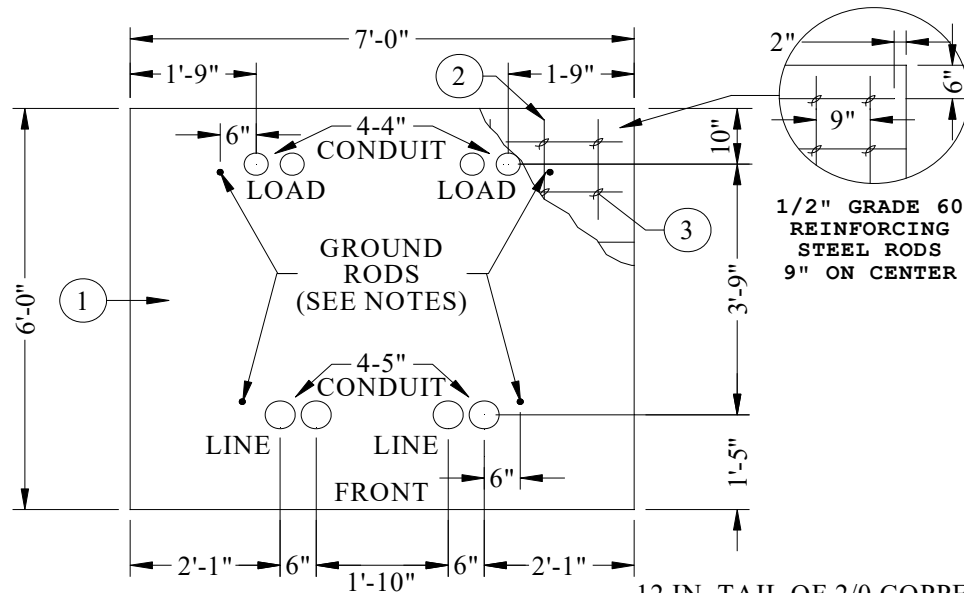

BOTTOM SLAB CONCRETE SHALL BE 4 SACK AND CONFORM TO ASTM C-150 AND SHALL HAVE A COMPRESSIVE STRENGTH OF 2000 LBS. AT 28 DAYS. MAXIMUM AGGREGATE SIZE SHALL NOT EXCEED 3/8 IN. REINFORCING RODS SHALL BE INTERMEDIATE GRADE (GRADE 60) AND SHALL CONFORM TO ASTM A-615.

TOP SLAB CONCRETE SHALL BE 5 SACK AND CONFORM TO ASTM C-150 AND SHALL HAVE A COMPRESSIVE STRENGTH OF 3000 LBS. AT 28 DAYS. CONCRETE SLUMP SHALL BE NO MORE THAN 4-IN. MAXIMUM AGGREGATE SIZE SHALL NOT EXCEED 1-1/2 IN. REINFORCING RODS SHALL BE INTERMEDIATE GRADE (GRADE 60) AND SHALL CONFORM TO ASTM A-615.

NOTES

1. 35' OF 2/0 STRANDED BARE SOFT-DRAWN, TINNED COPPER GROUND WITH 2" CONCRETE ENCASEMENT OR 5/8"x8'-0" CU. COPPERWELD GROUND ROD. (SEE GROUNDING DETAIL 1488-10 AND 1488-20).
2. STEEL BARRIER POSTS WILL BE REQUIRED WHENEVER SWITCHGEAR PAD IS INSTALLED WITHIN 4' OF A TRAFFIC AREA. (SEE BARRIER POST DETAIL DRAWING FOR CONSTRUCTION DETAILS AND CLEARANCE REQUIREMENTS.)
3. 90 DEG. (24" RADIUS (MIN.)) CONDUIT BEND SHALL BE COMPLETELY CONCRETE ENCASED.
4. CONCRETE SHALL BE 5 SACK, CLASS A, 3/4 IN. TO 1-1/2 IN. AGGREGATE.
5. BELL ENDS SHALL BE 1" ABOVE SLAB.

1438-14
Sheet 1 of 2
Rev: 08/01/20

CIVIL
PADS, CLEARANCES AND BARRIERS
SWITCHGEAR PAD 3PH PME-10

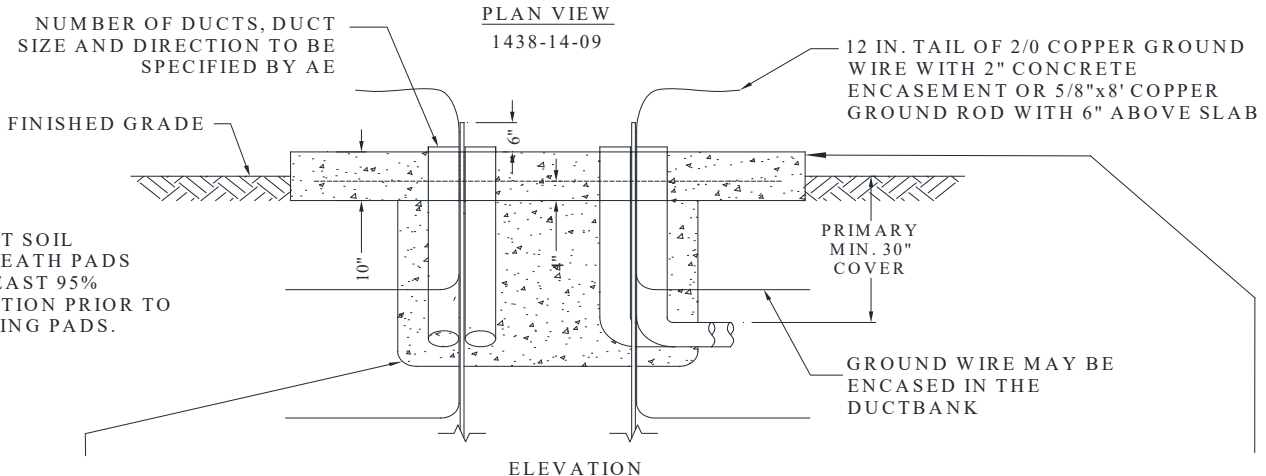
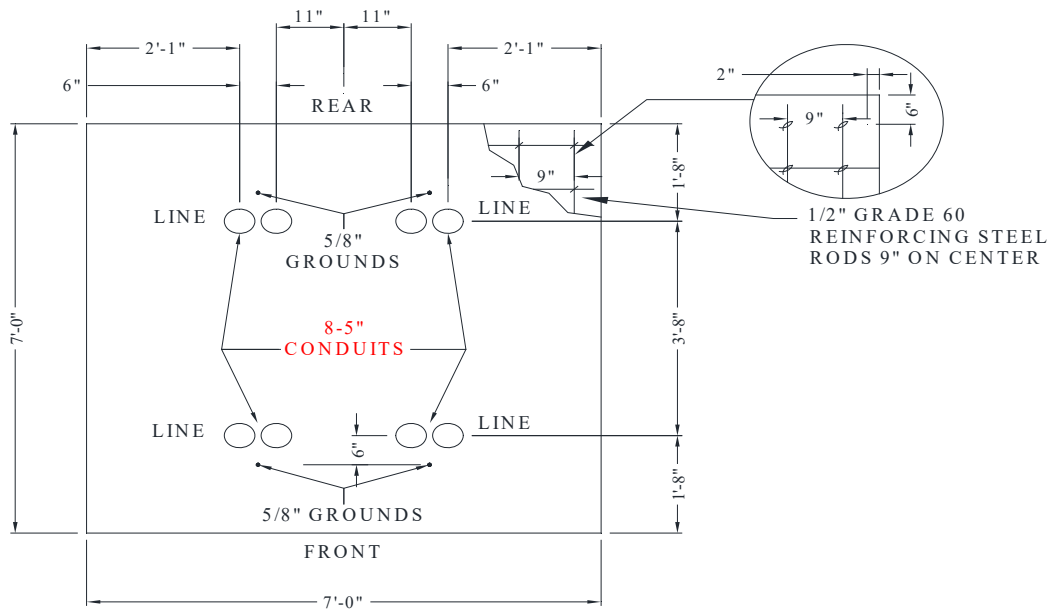
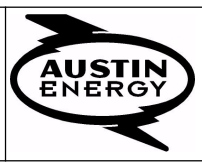

BOTTOM SLAB CONCRETE SHALL BE 4 SACK AND CONFORM TO ASTM C-150 AND SHALL HAVE A COMPRESSIVE STRENGTH OF 2000 LBS. AT 28 DAYS. MAXIMUM AGGREGATE SIZE SHALL NOT EXCEED 3/8 IN. REINFORCING RODS SHALL BE INTERMEDIATE GRADE (GRADE 60) AND SHALL CONFORM TO ASTM A-615.

CONCRETE SHALL CONFORM TO ASTM C-150 AND SHALL HAVE A COMPRESSIVE STRENGTH OF 3000 LBS. AT 28 DAYS. CONCRETE SLUMP SHALL BE NO MORE THAN 4-IN. MAXIMUM AGGREGATE SIZE SHALL NOT EXCEED 1-1/2 IN. REINFORCING RODS SHALL BE INTERMEDIATE GRADE (GRADE 60) AND SHALL CONFORM TO ASTM A-615.

- NOTES
- 35' OF 2/0 STRANDED BARE SOFT-DRAWN, TINNED COPPER GROUND WITH 2" CONCRETE ENCASUREMENT OR 5/8"x8'-0" CU. COPPERWELD GROUND ROD. (SEE GROUNDING DETAIL 1488-10 AND 1488-20).
 - STEEL BARRIER POSTS WILL BE REQUIRED WHENEVER SWITCHGEAR PAD IS INSTALLED WITHIN 4' OF A TRAFFIC AREA. (SEE BARRIER POST DETAIL DRAWING FOR CONSTRUCTION DETAILS AND CLEARANCE REQUIREMENTS.)
 - 90 DEG. (24" RADIUS (MIN.)) CONDUIT BEND SHALL BE COMPLETELY CONCRETE ENCASED.
 - CONCRETE SHALL BE 5 SACK, CLASS A, 3/4 IN. TO 1-1/2 IN. AGGREGATE.
 - BELL ENDS SHALL BE 1" ABOVE SLAB.

1438-14	CIVIL	PADS, CLEARANCES AND BARRIERS SWITCHGEAR PAD 3PH PME- 10	
Sheet 2 of 2			
Rev: 08/01/20			

CU

CU- ID	CU- REF	CU- DESCRIPTION
---------------	----------------	------------------------

SWTGRPD3PHPME10DFE	14381409E	SWGR PAD 3 PHASE PME-10 DEAD FRONT EAST
--------------------	-----------	---

ID	PART NUM	PART DESC	QTY	EA	CU- REF
1	0000001295	STEEL ROUND REINF GRADE 60 #3 X 20 FT LENGTH	10	EA	14381409E
6	0000001402	CONCRETE 5 SACK CLASS A	6.5	EA	14381409E
3	0000004523	WIRE COP BARE MHD SOLID # 6 25LB/315/FT	20	EA	14381409E
4	0000007469	ROD GROUND 5/8 IN X 8 FT COPPERWELD EL230	2	EA	14381409E
2	0000009487	WIRE STEEL BLACK # 16 3- 1/2LB COIL	100	EA	14381409E
5	0000017302	CLAMP GROUND VISE TYPE FOR 5/8 GROUND ROD CAST BRONZE	4	EA	14381409E

SWTGRPD3PHPME10DFW	14381409W	SWGR PAD 3 PHASE PME-10 DEAD FRONT WEST
--------------------	-----------	---

ID	PART NUM	PART DESC	QTY	EA	CU- REF
1	0000001295	STEEL ROUND REINF GRADE 60 #3 X 20 FT LENGTH	10	EA	14381409W
5	0000001402	CONCRETE 5 SACK CLASS A	6.5	EA	14381409W
3	0000004523	WIRE COP BARE MHD SOLID # 6 25LB/315/FT	20	EA	14381409W
4	0000006806	CONNECTOR SPLIT BOLT #6 SOLID COP	4	EA	14381409W
2	0000009487	WIRE STEEL BLACK # 16 3- 1/2LB COIL	100	EA	14381409W

FOR DETAILS	SEE PAGE
BARRIER POSTS AND CLEARANCE	1438- 10
STRUCTURE GROUNDING	1488- 10 AND 1488- 20
SWITCHGEAR	1561- 10

1438-16
Sheet 1 of 2
Rev: 08/01/20

CIVIL
PADS, CLEARANCES AND BARRIERS
SWITCHGEAR PAD 3PH PME-11

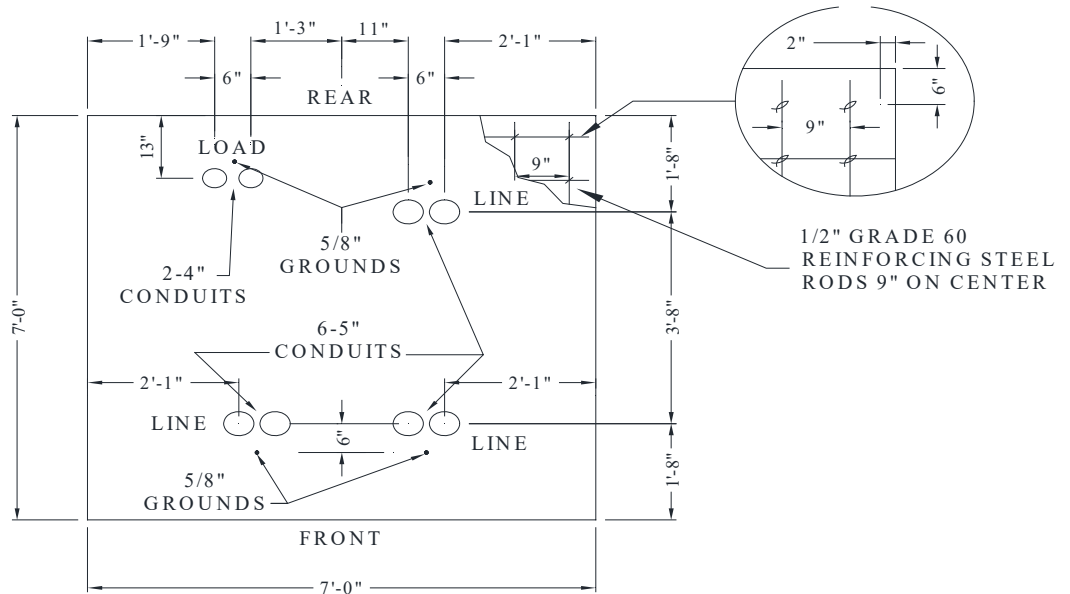

NUMBER OF DUCTS,
 DUCT SIZE AND
 DIRECTION TO BE
 SPECIFIED BY AE

PLAN VIEW
 1438-16-11

12 IN. TAIL OF 2/0 COPPER
 GROUND WIRE WITH 2"
 CONCRETE ENCASEMENT OR
 5/8"x8' COPPER GROUND ROD
 WITH 6" ABOVE SLAB

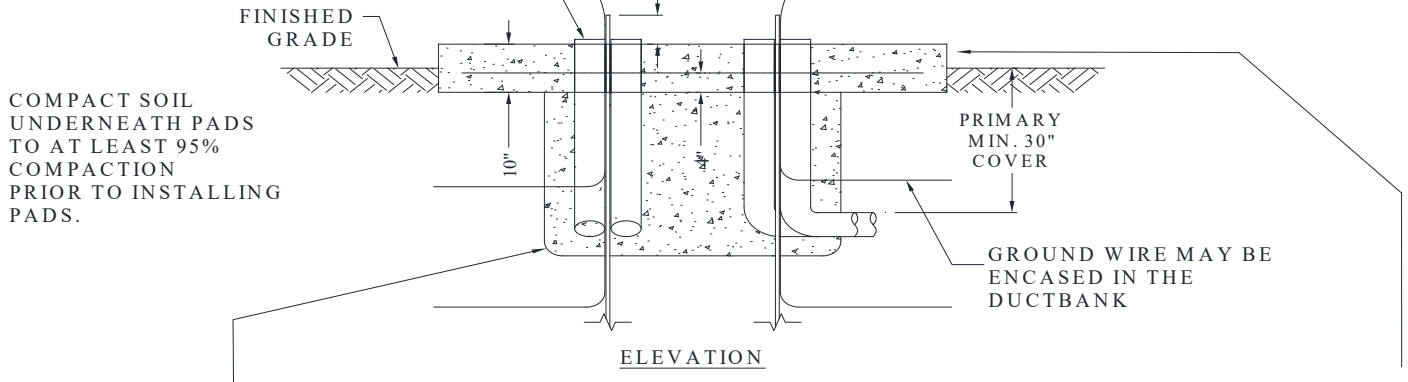

COMPACT SOIL
 UNDERNEATH PADS
 TO AT LEAST 95%
 COMPACTION
 PRIOR TO INSTALLING
 PADS.

ELEVATION

BOTTOM SLAB CONCRETE SHALL BE 4 SACK AND CONFORM TO ASTM C-150 AND SHALL HAVE A COMPRESSIVE STRENGTH OF 2000 LBS. AT 28 DAYS. MAXIMUM AGGREGATE SIZE SHALL NOT EXCEED 3/8 IN. REINFORCING RODS SHALL BE INTERMEDIATE GRADE (GRADE 60) AND SHALL CONFORM TO ASTM A-615.

CONCRETE SHALL CONFORM TO ASTM C-150 AND SHALL HAVE A COMPRESSIVE STRENGTH OF 3000 LBS. AT 28 DAYS. CONCRETE SLUMP SHALL BE NO MORE THAN 4-IN. MAXIMUM AGGREGATE SIZE SHALL NOT EXCEED 1-1/2 IN. REINFORCING RODS SHALL BE INTERMEDIATE GRADE (GRADE 60) AND SHALL CONFORM TO ASTM A-615.

NOTES

1. 35' OF 2/0 STRANDED BARE SOFT-DRAWN, TINNED COPPER GROUND WITH 2" CONCRETE ENCASEMENT OR 5/8"x8'-0" CU. COPPERWELD GROUND ROD. (SEE GROUNDING DETAIL 1488-10 AND 1488-20).
2. STEEL BARRIER POSTS WILL BE REQUIRED WHENEVER SWITCHGEAR PAD IS INSTALLED WITHIN 4' OF A TRAFFIC AREA. (SEE BARRIER POST DETAIL DRAWING FOR CONSTRUCTION DETAILS AND CLEARANCE REQUIREMENTS.)
3. 90 DEG. (24" RADIUS (MIN.)) CONDUIT BEND SHALL BE COMPLETELY CONCRETE ENCASED.
4. CONCRETE SHALL BE 5 SACK, CLASS A, 3/4 IN. TO 1-1/2 IN. AGGREGATE.
5. BELL ENDS SHALL BE 1" ABOVE SLAB.

1438-16	CIVIL PADS, CLEARANCES AND BARRIERS SWITCHGEAR PAD 3PH PME- 11	
Sheet 2 of 2		
Rev: 08/01/20		

CU

CU-ID	CU-REF	CU-DESCRIPTION
--------------	---------------	-----------------------

SWTGRPD3PHPME11DFE	14381611E	SWGR PAD 3 PHASE PME-11 DEAD FRONT EAST
--------------------	-----------	---

ID	PART NUM	PART DESC	QTY	EA	CU-REF
1	0000001295	STEEL ROUND REINF GRADE 60 #3 X 20 FT LENGTH	10	EA	14381611E
6	0000001402	CONCRETE 5 SACK CLASS A	6.5	EA	14381611E
3	0000004523	WIRE COP BARE MHD SOLID # 6 25LB/315/FT	20	EA	14381611E
4	0000007469	ROD GROUND 5/8 IN X 8 FT COPPERWELD EL230	2	EA	14381611E
2	0000009487	WIRE STEEL BLACK # 16 3- 1/2LB COIL	100	EA	14381611E
5	0000017302	CLAMP GROUND VISE TYPE FOR 5/8 GROUND ROD CAST BRONZE	4	EA	14381611E

SWTGRPD3PHPME11DFW	14381611W	SWGR PAD 3 PHASE PME-11 DEAD FRONT WEST
--------------------	-----------	---

ID	PART NUM	PART DESC	QTY	EA	CU-REF
1	0000001295	STEEL ROUND REINF GRADE 60 #3 X 20 FT LENGTH	10	EA	14381611W
5	0000001402	CONCRETE 5 SACK CLASS A	6.5	EA	14381611W
3	0000004523	WIRE COP BARE MHD SOLID # 6 25LB/315/FT	20	EA	14381611W
4	0000006806	CONNECTOR SPLIT BOLT #6 SOLID COP	4	EA	14381611W
2	0000009487	WIRE STEEL BLACK # 16 3- 1/2LB COIL	100	EA	14381611W

FOR DETAILS	SEE PAGE
BARRIER POSTS AND CLEARANCE	1438- 10
STRUCTURE GROUNDING	1488- 10 AND 1488- 20
SWITCHGEAR	1561- 11

THREE PHASE SWITCHGEAR PAD
CONDUITS AND UNDERGROUND STRUCTURES
PAD-MOUNTED PME-12 SWITCHGEAR



143

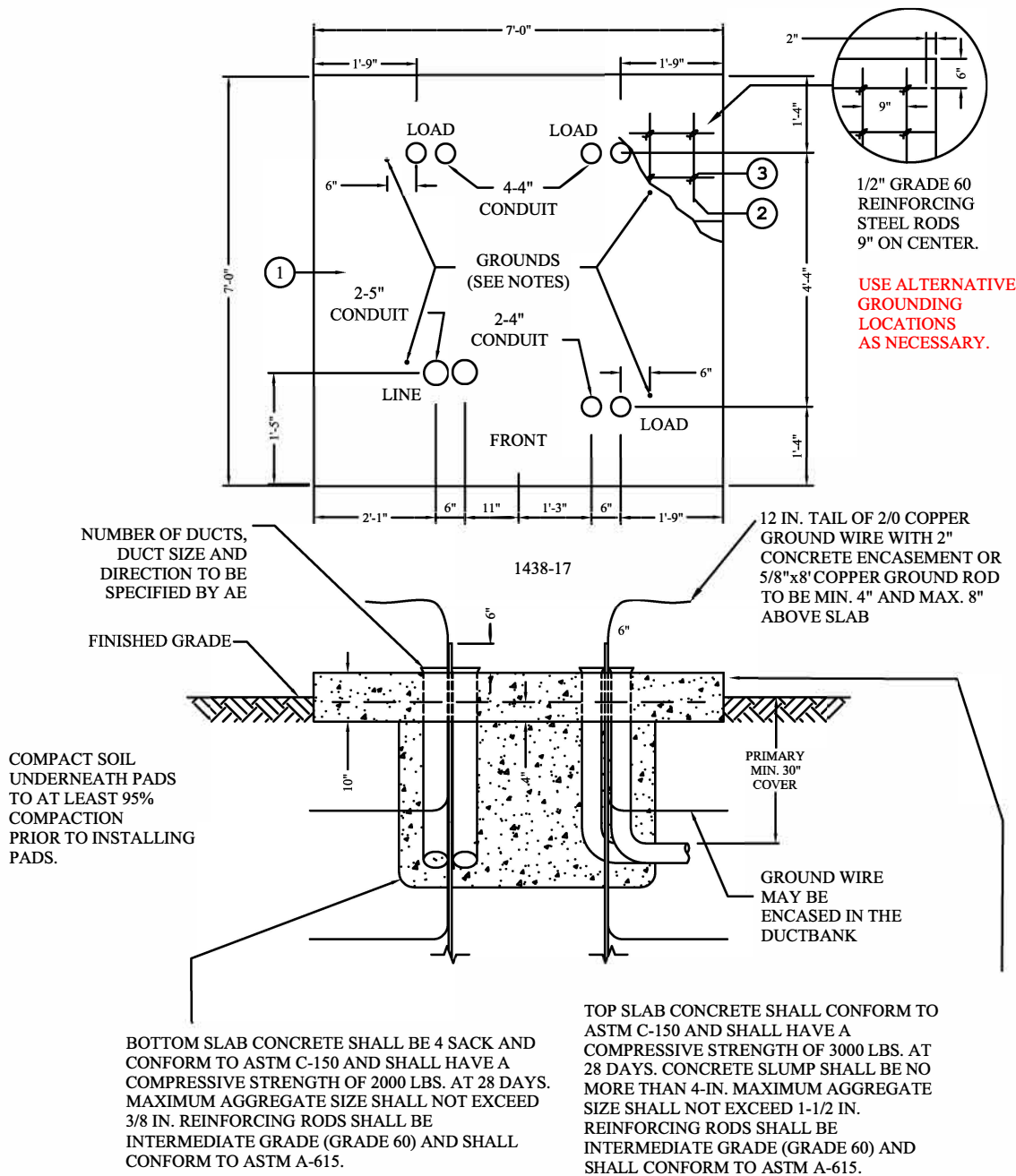

1/2" GRADE 60 REINFORCING STEEL RODS 9" ON CENTER.
USE ALTERNATIVE GROUNDING LOCATIONS AS NECESSARY.

COMPACT SOIL UNDERNEATH PADS TO AT LEAST 95% COMPACTION PRIOR TO INSTALLING PADS.

BOTTOM SLAB CONCRETE SHALL BE 4 SACK AND CONFORM TO ASTM C-150 AND SHALL HAVE A COMPRESSIVE STRENGTH OF 2000 LBS. AT 28 DAYS. MAXIMUM AGGREGATE SIZE SHALL NOT EXCEED 3/8 IN. REINFORCING RODS SHALL BE INTERMEDIATE GRADE (GRADE 60) AND SHALL CONFORM TO ASTM A-615.

TOP SLAB CONCRETE SHALL CONFORM TO ASTM C-150 AND SHALL HAVE A COMPRESSIVE STRENGTH OF 3000 LBS. AT 28 DAYS. CONCRETE SLUMP SHALL BE NO MORE THAN 4-IN. MAXIMUM AGGREGATE SIZE SHALL NOT EXCEED 1-1/2 IN. REINFORCING RODS SHALL BE INTERMEDIATE GRADE (GRADE 60) AND SHALL CONFORM TO ASTM A-615.

NOTES

1. 35' OF 2/0 STRANDED BARE SOFT-DRAWN, TINNED COPPER GROUND WITH 2" CONCRETE ENCASEMENT OR 5/8"x8'-0" CU. COPPERWELD GROUND ROD. (SEE GROUNDING DETAIL 1488-10 AND 1488-20).
2. STEEL BARRIER POSTS WILL BE REQUIRED WHENEVER SWITCHGEAR PAD IS INSTALLED WITHIN 4' OF A TRAFFIC AREA. (SEE BARRIER POST DETAIL DRAWING FOR CONSTRUCTION DETAILS AND CLEARANCE REQUIREMENTS.)
3. 90 DEG. (24" RADIUS (MIN.)) CONDUIT BEND SHALL BE COMPLETELY CONCRETE ENCASED.
4. CONCRETE SHALL BE 5 SACK, CLASS A, 3/4 IN. TO 1-1/2 IN. AGGREGATE.
5. BELL ENDS SHALL BE 1" ABOVE SLAB.

1438-17	CIVIL PADS, CLEARANCES AND BARRIERS SWITCHGEAR PAD 3PH PME-12	
Sheet 2 of 2		
Rev: 08/01/20		

CU

CU-ID **CU-REF** **CU-DESCRIPTION**

SWTGRPD3PHPME12DFE 14381712E SWGR PAD 3 PHASE PME-12 DEAD FRONT EAST

ID	PART NUM	PART DESC	QTY		CU-REF
1	0000001295	STEEL ROUND REINF GRADE 60 #3 X 20 FT LENGTH	10	EA	14381712E
6	0000001402	CONCRETE 5 SACK CLASS A	6.5	EA	14381712E
3	0000004523	WIRE COP BARE MHD SOLID # 6 25LB/315/FT	20	EA	14381712E
4	0000007469	ROD GROUND 5/8 IN X 8 FT COPPERWELD EL230	2	EA	14381712E
2	0000009487	WIRE STEEL BLACK # 16 3- 1/2LB COIL	100	EA	14381712E
5	0000017302	CLAMP GROUND VISE TYPE FOR 5/8 GROUND ROD CAST BRONZE	4	EA	14381712E

SWTGRPD3PHPME12DFW 14381712W SWGR PAD 3 PHASE PME-12 DEAD FRONT WEST

ID	PART NUM	PART DESC	QTY		CU-REF
1	0000001295	STEEL ROUND REINF GRADE 60 #3 X 20 FT LENGTH	5	EA	14381712
3	0000001402	CONCRETE 5 SACK CLASS A	3.25	EA	14381712
2	0000009487	WIRE STEEL BLACK # 16 3- 1/2LB COIL	85	EA	14381712

FOR DETAILS	SEE PAGE
BARRIER POSTS AND CLEARANCE	1438- 10
STRUCTURE GROUNDING	1488- 10 AND 1488- 20
SWITCHGEAR	1561- 12

1438-22
Sheet 1 of 1
Rev: 08/01/20

CIVIL
PADS, CLEARANCES AND BARRIERS
PAD CIP SECTIONALIZING CAB 1, 2 & 3 CIRCUIT

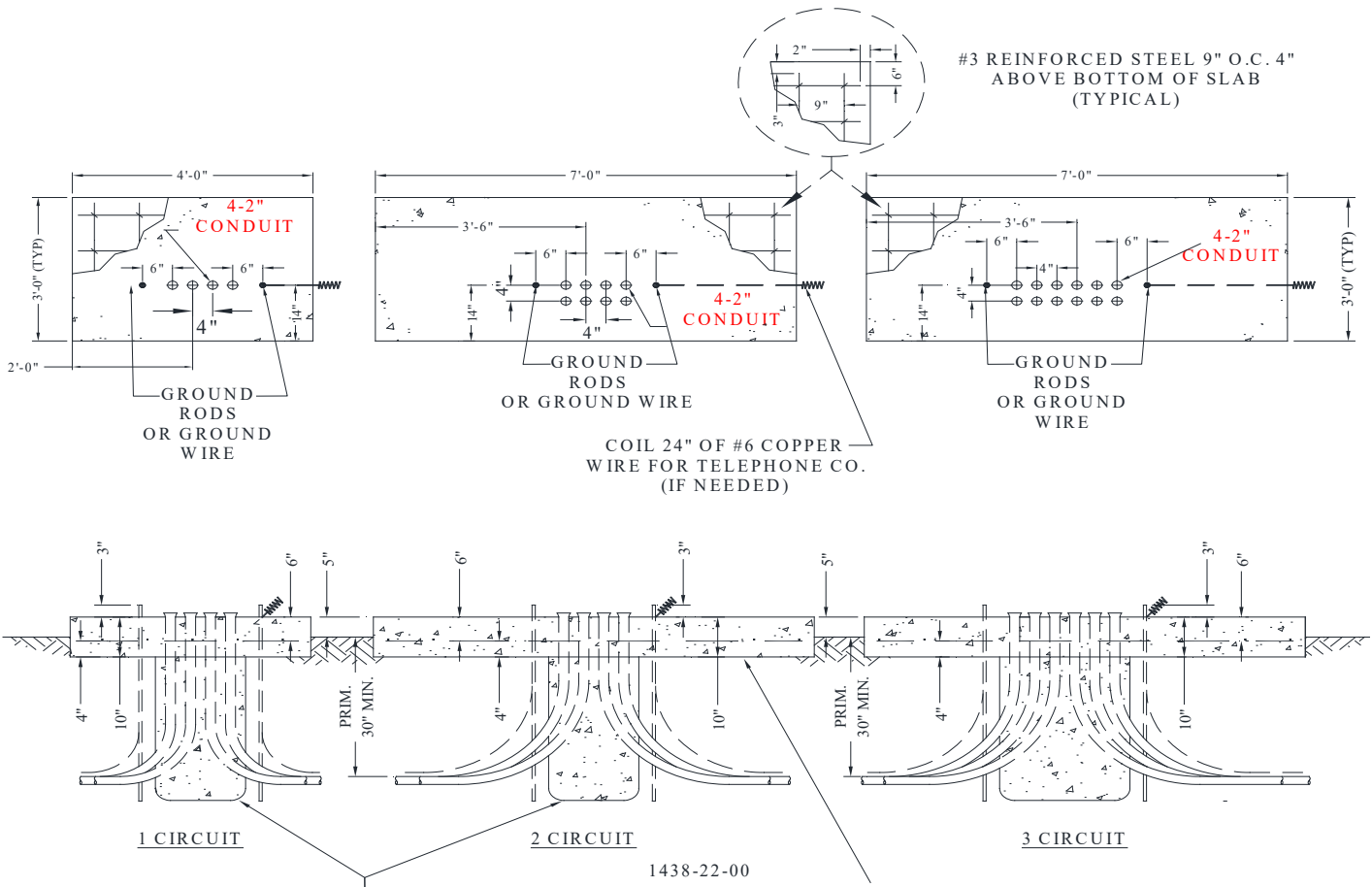
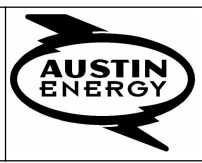

BOTTOM SLAB CONCRETE SHALL BE 4 SACK AND CONFORM TO ASTM C-150 AND SHALL HAVE A COMPRESSIVE STRENGTH OF 2000 LBS. AT 28 DAYS. MAXIMUM AGGREGATE SIZE SHALL NOT EXCEED 3/8 IN. REINFORCING RODS SHALL BE INTERMEDIATE GRADE (GRADE 60) AND SHALL CONFORM TO ASTM A-615.

TOP SLAB CONCRETE SHALL CONFORM TO ASTM C-150 AND SHALL HAVE A COMPRESSIVE STRENGTH OF 3000 LBS. AT 28 DAYS. CONCRETE SLUMP SHALL BE NO MORE THAN 4-IN. MAXIMUM AGGREGATE SIZE SHALL NOT EXCEED 1-1/2 IN. REINFORCING RODS SHALL BE INTERMEDIATE GRADE (GRADE 60) AND SHALL CONFORM TO ASTM A-615.

NOTES:

1. A MAXIMUM OF 4 CONDUITS AND 4 SETS OF CABLE PER PHASE CAN BE INSTALLED IN THE ARRANGEMENT AND NUMERICAL ORDERED AS SHOWN.
2. FOR SHELL BUILDINGS, STUB ALL SPARE CONDUITS AT THE BUILDING SERVICE RISER.
3. 35' OF 2/0 STRANDED BARE SOFT-DRAWN, TINNED COPPER GROUND OR 5/8"x8' CU. COPPERWELD GROUND ROD. (SEE GROUNDING DETAIL 1488-10 OR 1488-20)
4. STEEL BARRIER POSTS WILL BE REQUIRED WHENEVER LOAD BREAK SECTIONALIZING CABINET IS PAD INSTALLED WITHIN 4' OF A TRAFFIC AREA. (SEE BARRIER POST DETAIL DRAWING 1400-10, FOR CONSTRUCTION DETAILS AND CLEARANCE REQUIREMENTS.)
5. COMPACT SOIL BENEATH PADS TO AT LEAST 95% COMPACTION, PRIOR TO INSTALLING PADS. AUSTIN ENERGY MUST INSPECT PAD AND APPROVE PRIOR TO POURING ANY CONCRETE.
6. GRADE AREA AROUND THE PAD, SO THAT DRAINAGE IS ALWAYS AWAY FROM THE PAD. RETAINING WALLS AND DRAINAGE CHANNELS MAY BE REQUESTED BY THE UTILITY, TO PREVENT WATER AND DEBRIS FROM ACCUMULATING ON THE ROAD.
7. 90° (MIN. 24" RADIUS) CONDUIT BEND SHALL BE COMPLETELY CONCRETE ENCASED.
8. BELL ENDS SHALL BE 1" ABOVE SLAB.

1438-24
Sheet 1 of 2
Rev: 08/01/20

CIVIL
PADS, CLEARANCES AND BARRIERS
PAD CIP LOAD BREAK SECTIONALIZING CABINET

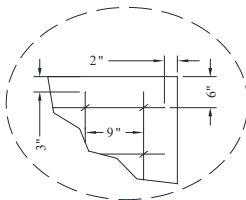
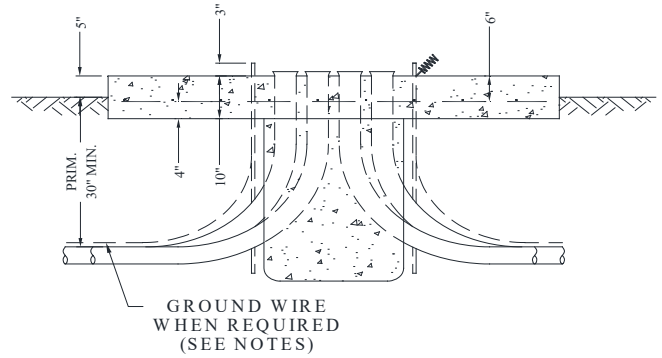
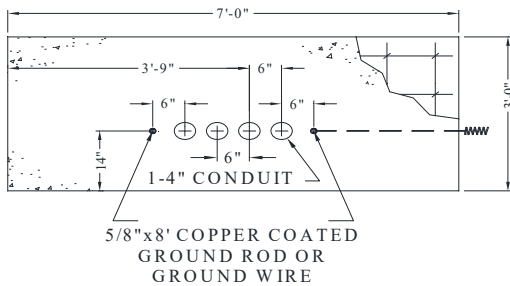

#3 REINFORCED STEEL 9" O.C.
4" ABOVE BOTTOM OF SLAB
(TYPICAL)

INSTALL #6 BARE COPPER WIRE 3"
BELOW TOP OF SLAB FOR TELECO &
LEAVE 12" EXPOSED ABOVE SLAB
TO BE CONNECTED TO GROUND
ROD WHEN CONNECTIONS ARE
MADE IN THE TRANSFORMER

1438-24-00

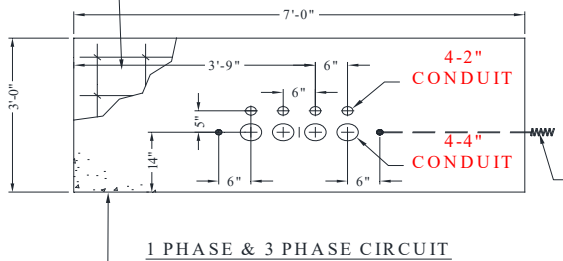

COIL 24" OF #6
COPPER WIRE
FOR TELEPHONE
CO. (IF NEEDED)

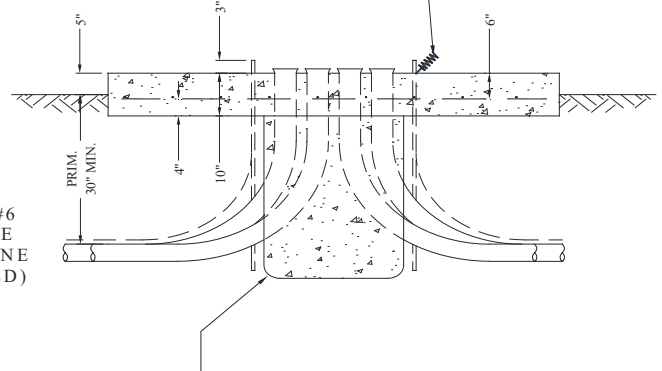

TOP SLAB CONCRETE SHALL CONFORM TO ASTM C-150 AND SHALL HAVE A COMPRESSIVE STRENGTH OF 3000 LBS. AT 28 DAYS. CONCRETE SLUMP SHALL BE NO MORE THAN 4-IN. MAXIMUM AGGREGATE SIZE SHALL NOT EXCEED 1-1/2 IN. REINFORCING RODS SHALL BE INTERMEDIATE GRADE (GRADE 60) AND SHALL CONFORM TO ASTM A-615.

BOTTOM SLAB CONCRETE SHALL BE 4 SACK AND CONFORM TO ASTM C-150 AND SHALL HAVE A COMPRESSIVE STRENGTH OF 2000 LBS. AT 28 DAYS. MAXIMUM AGGREGATE SIZE SHALL NOT EXCEED 3/8 IN. REINFORCING RODS SHALL BE INTERMEDIATE GRADE (GRADE 60) AND SHALL CONFORM TO ASTM A-615.

NOTES:

1. A MAXIMUM OF 4 CONDUITS AND 4 SETS OF CABLE PER PHASE CAN BE INSTALLED IN THE ARRANGEMENT AND NUMERICAL ORDERED AS SHOWN.
2. FOR SHELL BUILDINGS, STUB ALL SPARE CONDUITS AT THE BUILDING SERVICE RISER.
3. 35' OF 2/0 STRANDED BARE SOFT-DRAWN, TINNED COPPER GROUND OR 5/8"x8' CU. COPPERWELD GROUND ROD. (SEE GROUNDING DETAIL 1488-10 OR 1488-20)
4. STEEL BARRIER POSTS WILL BE REQUIRED WHENEVER LOAD BREAK SECTIONALIZING CABINET IS PAD INSTALLED WITHIN 4' OF A TRAFFIC AREA. (SEE BARRIER POST DETAIL DRAWING 1400-10, FOR CONSTRUCTION DETAILS AND CLEARANCE REQUIREMENTS.)
5. COMPACT SOIL BENEATH PADS TO AT LEAST 95% COMPACTION, PRIOR TO INSTALLING PADS. AUSTIN ENERGY MUST INSPECT PAD AND APPROVE PRIOR TO POURING ANY CONCRETE.
6. GRADE AREA AROUND THE PAD, SO THAT DRAINAGE IS ALWAYS AWAY FROM THE PAD. RETAINING WALLS AND DRAINAGE CHANNELS MAY BE REQUESTED BY THE UTILITY, TO PREVENT WATER AND DEBRIS FROM ACCUMULATING ON THE ROAD.
7. 90° (MIN. 24" RADIUS) CONDUIT BEND SHALL BE COMPLETELY CONCRETE ENCASED.
8. BELL ENDS SHALL BE 1" ABOVE SLAB.

1438-24	CIVIL PADS, CLEARANCES AND BARRIERS PAD CIP LOAD BREAK SECTIONALIZING CABINET	
Sheet 2 of 2		
Rev: 08/01/20		

CU

CU-ID CU-REF CU-DESCRIPTION

PADSECTLOADBREAK1PHASE 143824A01 PAD SECTIONALIZING LOADBREAK 1 PHASE

ID	PART NUM	PART DESC	QTY		CU-REF
1	0000001295	STEEL ROUND REINF GRADE 60 #3 X 20 FT LENGTH	3	EA	143824A01
6	0000001402	CONCRETE 5 SACK CLASS A	1	EA	143824A01
3	0000004523	WIRE COP BARE MHD SOLID # 6 25LB/315/FT	1	EA	143824A01
4	0000007469	ROD GROUND 5/8 IN X 8 FT COPPERWELD EL230	2	EA	143824A01
2	0000009487	WIRE STEEL BLACK # 16 3- 1/2LB COIL	1	EA	143824A01
5	0000017302	CLAMP GROUND VISE TYPE FOR 5/8 GROUND ROD CAST BRONZE	4	EA	143824A01

PADSECTLOADBREAK3PHASE 143824B01 PAD SECTIONALIZING LOADBREAK 3 PHASE

ID	PART NUM	PART DESC	QTY		CU-REF
1	0000001295	STEEL ROUND REINF GRADE 60 #3 X 20 FT LENGTH	3	EA	143824B01
6	0000001402	CONCRETE 5 SACK CLASS A	1	EA	143824B01
3	0000004523	WIRE COP BARE MHD SOLID # 6 25LB/315/FT	1	EA	143824B01
4	0000007469	ROD GROUND 5/8 IN X 8 FT COPPERWELD EL230	2	EA	143824B01
2	0000009487	WIRE STEEL BLACK # 16 3- 1/2LB COIL	1	EA	143824B01
5	0000017302	CLAMP GROUND VISE TYPE FOR 5/8 GROUND ROD CAST BRONZE	4	EA	143824B01

1438-28	CIVIL	
Sheet 1 of 1	PADS, CLEARANCES AND BARRIERS	
Rev: 08/01/20	NOTES FOR VISTA PAD DETAILS	

VISTA PAD DETAIL NOTES:

1. A. GROUND ROD DETAIL 1488-10 (PREFERRED)
 THE GROUND ROD SHALL BE INSTALLED AS PER SECTION 1488-10. THE GROUND ROD SHALL BE INSTALLED NO LESS THAN 4 INCHES AND NO GREATER THAN 6 INCHES ABOVE THE PAD SURFACE. WHEN A BURIED GROUND ELECTRODE IS INSTALLED, A 2/0 AWG STRANDED BARE SOFT DRAWN TINNED COPPER WIRE SHALL BE BONDED TO THE GROUND ROD WITH A MINIMUM 12 INCHES OF TAIL EXPOSED ABOVE THE FINISHED CONCRETE PAD SURFACE. THE GROUND ROD SHALL BE 5/8 INCH X 8 FEET COPPER CLAD.

- B. GROUND ROD DETAIL 1488-20 (OPTIONAL)
 IN CONDITIONS WHERE THE INSTALLATION OF A GROUND ROD IS NOT FEASIBLE, 35 FEET OF 2/0 AWG STRANDED BARE SOFT DRAWN COPPER WIRE ENCASED BY A 2 INCH CONCRETE ENVELOPE SHALL BE INSTALLED AS PER SECTION 1488-20. A 2/0 AWG STRANDED BARE SOFT DRAWN TINNED COPPER WIRE SHALL BE BONDED TO THE 2/0 GROUND WIRE WITH A MINIMUM 12 INCH TAIL EXPOSED ABOVE THE CONCRETE PAD SURFACE.

2. STEEL BARRIER POST WILL BE REQUIRED WHENEVER SWITCHGEAR PAD IS INSTALLED WITHIN 4 FEET OF A TRAFFIC AREA. SEE BARRIER POST DETAIL DRAWING 1438-10, FOR CONSTRUCTION DETAILS AND CLEARANCE REQUIREMENTS.

3. COMPACT SOIL UNDER PADS TO AT LEAST 95% COMPACTION PRIOR TO INSTALLING PADS. AUSTIN ENERGY MUST INSPECT PAD AND APPROVE PRIOR TO POURING ANY CONCRETE.

4. CONCRETE SHALL CONFORM TO ASTM C-150 AND SHALL HAVE A COMPRESSIVE STRENGTH OF 3000 LBS AT 28 DAYS. CONCRETE SLUMP SHALL BE NO MORE THAN 4 INCHES. MAXIMUM AGGREGATE SIZE SHALL NOT EXCEED 1-1/2 INCHES. REINFORCING RODS SHALL BE INTERMEDIATE GRADE (GRADE 60) AND SHALL CONFORM TO ASTM-615.

5. 90 DEGREE (MIN 24 INCH RADIUS) CONDUIT BEND SHALL BE COMPLETELY CONCRETE ENCASED.

6. BELL ENDS SHALL BE 1 INCH ABOVE PAD.

7. 5 INCH CONDUITS FOR LINE SIDE AND LOAD SIDE SHALL BE USED.

1438-31
Sheet 1 of 2
Rev: 08/01/20

CIVIL
PADS, CLEARANCES AND BARRIERS
SWGR PAD VISTA 3 WAY 600 & 900A

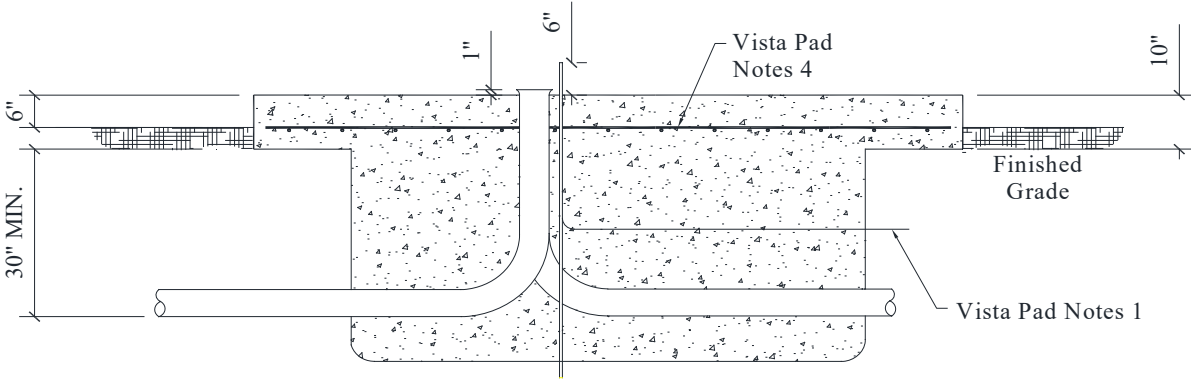
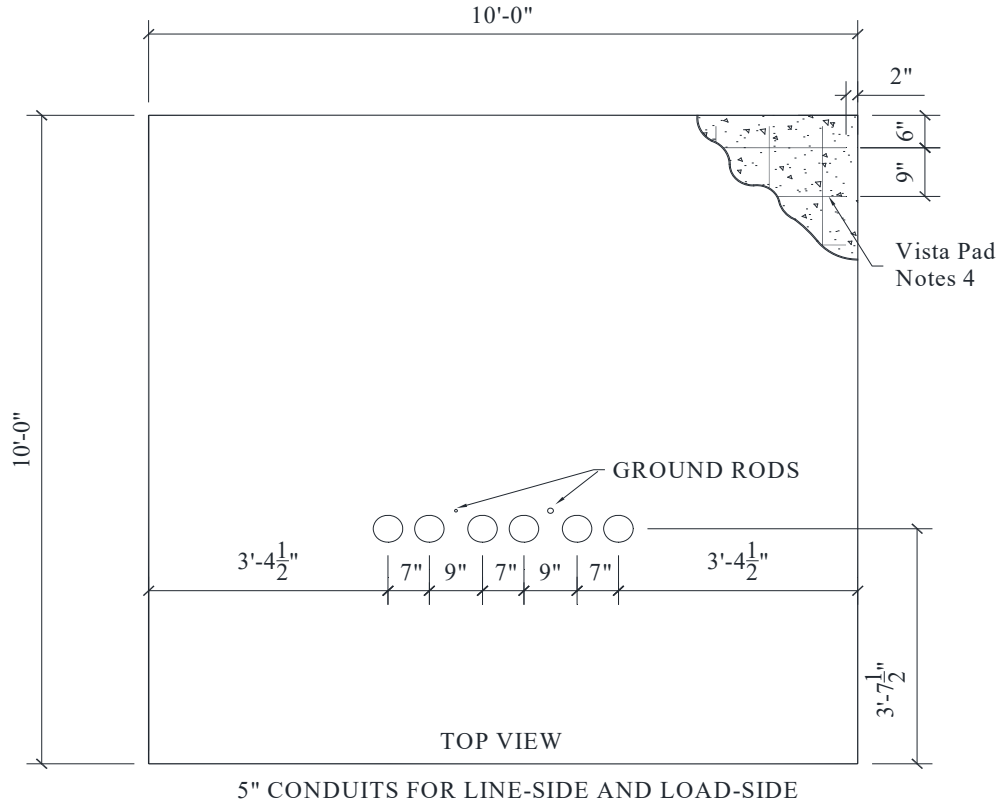
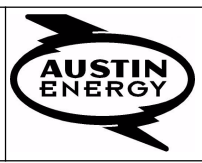

REFER TO VISTA PAD DETAIL NOTES ON SECTION 1438-28 FOR DETAILS ON VISTA SWITCHGEAR CONCRETE PAD CONSTRUCTION.

1438-31	CIVIL PADS, CLEARANCES AND BARRIERS SWGR PAD VISTA 3 WAY 600 & 900A	
Sheet 2 of 2		
Rev: 08/01/20		

CU

CU-ID	CU-REF	CU-DESCRIPTION
--------------	---------------	-----------------------

SWTGRVISTA3WAY600-900A	14383110E	PDMT SWTGR VISTA 3-WAY 600 & 900 AMP E
------------------------	-----------	--

ID	PART NUM	PART DESC	QTY	EA	CU-REF
1	0000001295	STEEL ROUND REINF GRADE 60 #3 X 20 FT LENGTH	10	EA	14383110E
2	0000009487	WIRE STEEL BLACK # 16 3- 1/2LB COIL	100	EA	14383110E
3	0000004523	WIRE COP BARE MHD SOLID # 6 25LB/315/FT	20	EA	14383110E
4	0000007469	ROD GROUND 5/8 IN X 8 FT COPPERWELD EL230	2	EA	14383110E
5	0000017302	CLAMP GROUND VISE TYPE FOR 5/8 GROUND ROD CAST BRONZE	4	EA	14383110E
6	0000001402	CONCRETE 5 SACK CLASS A	6.5	EA	14383110E

SWTGRVISTA3WAY600-900AW	14383110W	PDMT SWTGR VISTA 3-WAY 600 & 900 AMP W
-------------------------	-----------	--

ID	PART NUM	PART DESC	QTY	EA	CU-REF
1	0000001295	STEEL ROUND REINF GRADE 60 #3 X 20 FT LENGTH	10	EA	14383110W
2	0000009487	WIRE STEEL BLACK # 16 3- 1/2LB COIL	100	EA	14383110W
3	0000004523	WIRE COP BARE MHD SOLID # 6 25LB/315/FT	20	EA	14383110W
4	0000007469	ROD GROUND 5/8 IN X 8 FT COPPERWELD EL230	2	EA	14383110W
5	0000017302	CLAMP GROUND VISE TYPE FOR 5/8 GROUND ROD CAST BRONZE	4	EA	14383110W
6	0000001402	CONCRETE 5 SACK CLASS A	6.5	EA	14383110W

FOR DETAILS	SEE PAGE
BARRIER POSTS AND CLEARANCE	1438- 10
STRUCTURE GROUNDING	1488- 10 AND 1488- 20

1438-36
Sheet 1 of 2
Rev: 08/01/20

CIVIL
PADS, CLEARANCES AND BARRIERS
VISTA 4 WAY 600 AND 900 AMP PAD DETAIL

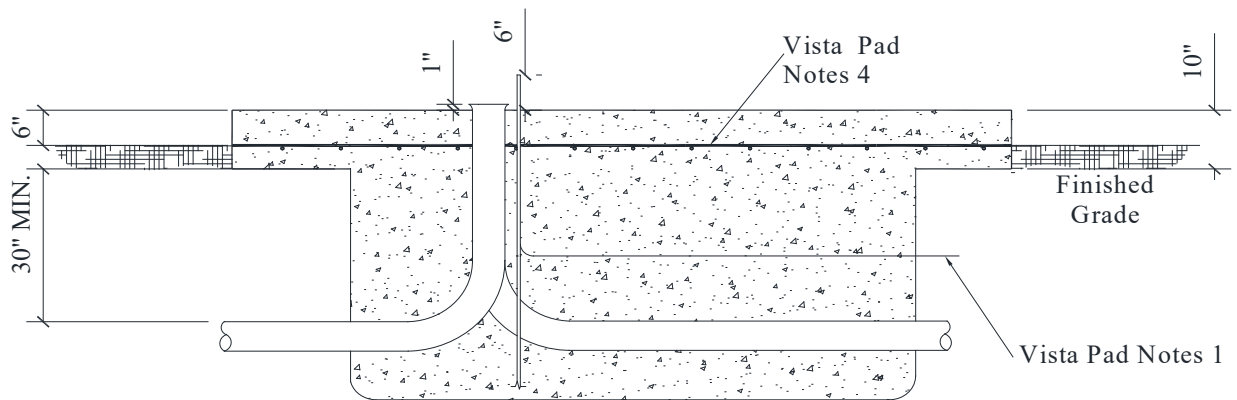
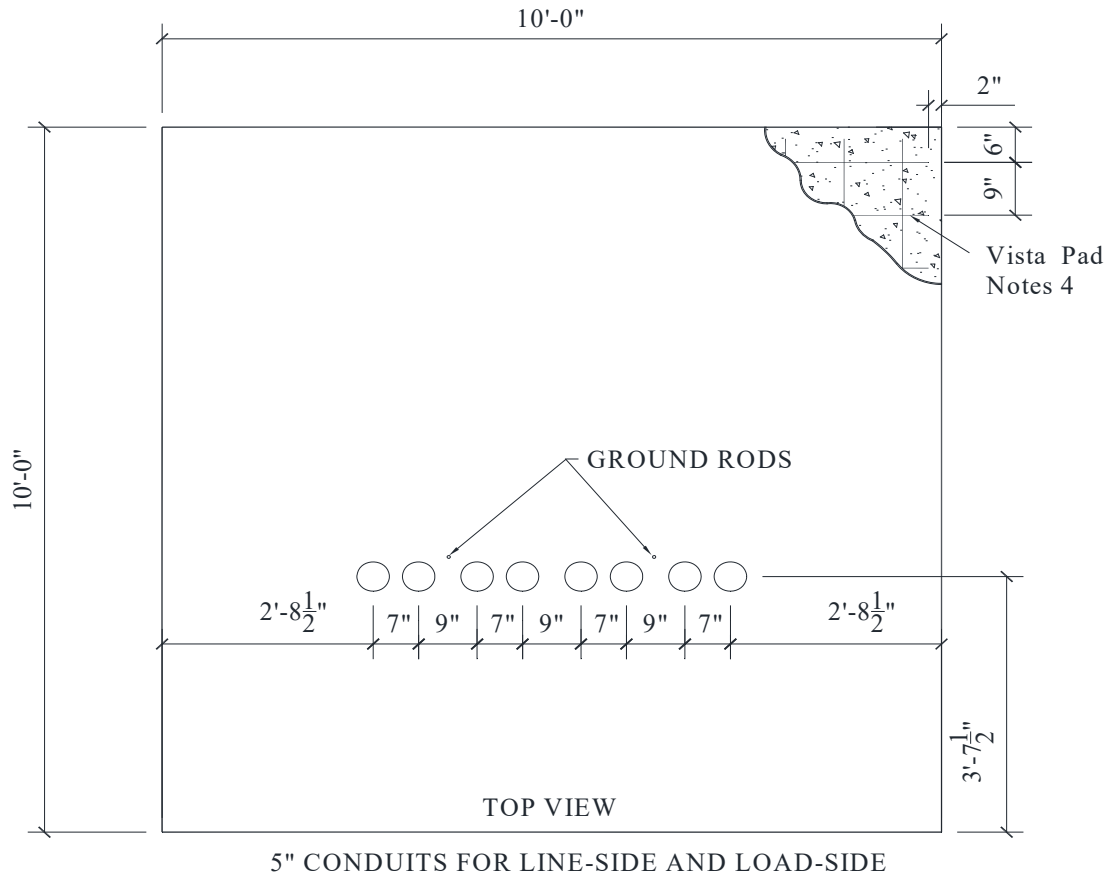
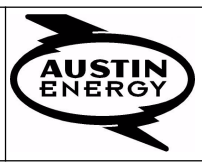

REFER TO VISTA PAD DETAIL NOTES ON SECTION 1438-28 FOR DETAILS ON VISTA SWITCHGEAR CONCRETE PAD CONSTRUCTION.

1438-36	CIVIL	
Sheet 2 of 2	PADS, CLEARANCES AND BARRIERS	
Rev: 08/01/20	VISTA 4 WAY 600 AND 900 AMP PAD DETAIL	

CU

CU-ID	CU-REF	CU-DESCRIPTION
--------------	---------------	-----------------------

SWTGRVISTA4WAY600-900A	14383610E	PDMT SWTGR VISTA 4-WAY 600 & 900A E
------------------------	-----------	-------------------------------------

ID	PART NUM	PART DESC	QTY	EA	CU-REF
1	0000001295	STEEL ROUND REINF GRADE 60 #3 X 20 FT LENGTH	10	EA	14383610E
2	0000009487	WIRE STEEL BLACK # 16 3-1/2LB COIL	100	EA	14383610E
3	0000004523	WIRE COP BARE MHD SOLID # 6 25LB/315/FT	20	EA	14383610E
4	0000007469	ROD GROUND 5/8 IN X 8 FT COPPERWELD EL230	2	EA	14383610E
5	0000017302	CLAMP GROUND VISE TYPE FOR 5/8 GROUND ROD CAST BRONZE	4	EA	14383610E
6	0000001402	CONCRETE 5 SACK CLASS A	6.5	EA	14383610E

SWTGRVISTA4WAY600-900AW	14383610W	PDMT SWTGR VISTA 4-WAY 600 & 900A W
-------------------------	-----------	-------------------------------------

ID	PART NUM	PART DESC	QTY	EA	CU-REF
1	0000001295	STEEL ROUND REINF GRADE 60 #3 X 20 FT LENGTH	10	EA	14383610W
2	0000009487	WIRE STEEL BLACK # 16 3-1/2LB COIL	100	EA	14383610W
3	0000004523	WIRE COP BARE MHD SOLID # 6 25LB/315/FT	20	EA	14383610W
4	0000007469	ROD GROUND 5/8 IN X 8 FT COPPERWELD EL230	2	EA	14383610W
5	0000017302	CLAMP GROUND VISE TYPE FOR 5/8 GROUND ROD CAST BRONZE	4	EA	14383610W
6	0000001402	CONCRETE 5 SACK CLASS A	6.5	EA	14383610W

FOR DETAILS	SEE PAGE
BARRIER POSTS AND CLEARANCE	1438- 10
STRUCTURE GROUNDING	1488- 10 AND 1488- 20

1438-41
Sheet 1 of 2
Rev: 08/01/20

CIVIL
PADS, CLEARANCES AND BARRIERS
VISTA 6 WAY 600 AND 900 AMP PAD DETAIL

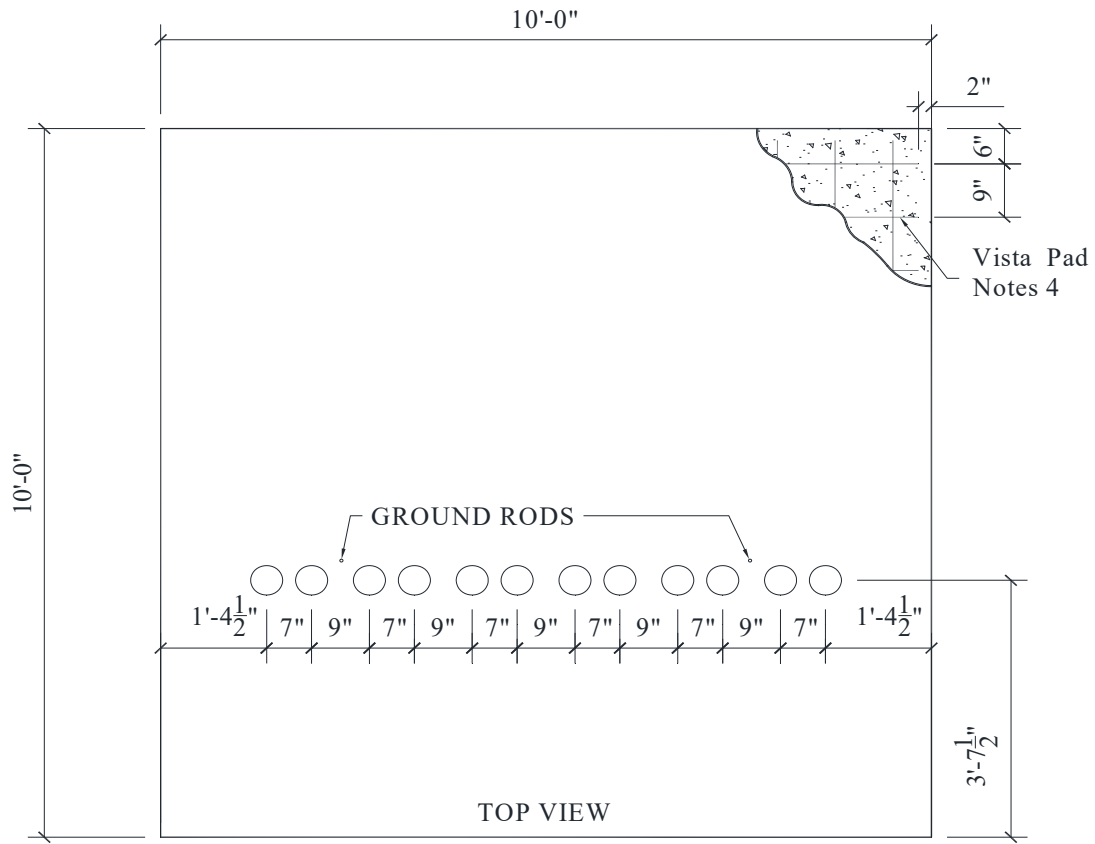
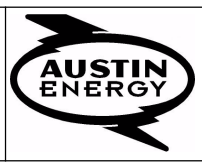

5" CONDUITS FOR LINE-SIDE AND LOAD-SIDE

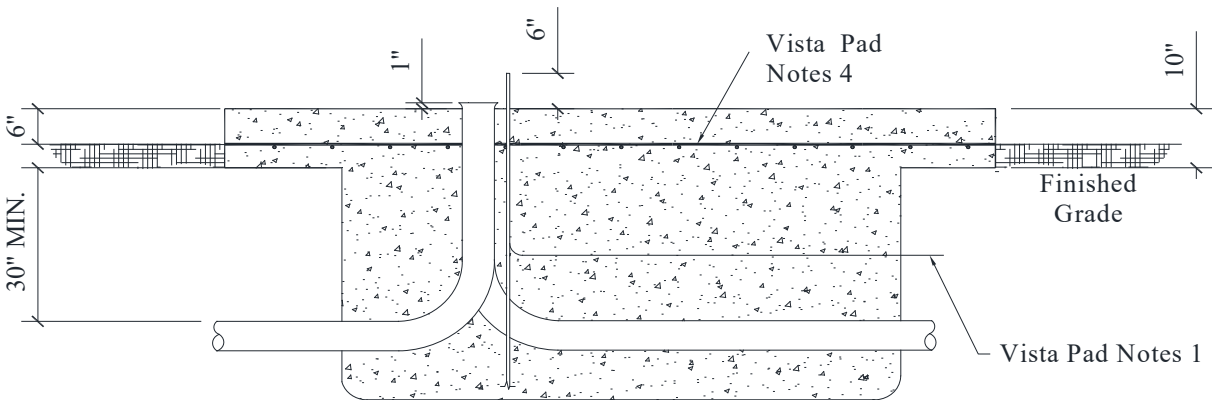

REFER TO VISTA PAD DETAIL NOTES ON SECTION 1438-28 FOR DETAILS ON VISTA SWITCHGEAR CONCRETE PAD CONSTRUCTION.

1438-41	CIVIL	
Sheet 2 of 2	PADS, CLEARANCES AND BARRIERS	
Rev: 08/01/20	VISTA 6 WAY 600 AND 900 AMP PAD DETAIL	

CU

CU-ID CU-REF CU-DESCRIPTION

SWTGRVISTA6WAY600-900A 14384110E PDMT SWTGR VISTA 6-WAY 600 - 900A E

ID	PART NUM	PART DESC	QTY		CU-REF
1	0000001295	STEEL ROUND REINF GRADE 60 #3 X 20 FT LENGTH	10	EA	14384110E
2	0000009487	WIRE STEEL BLACK # 16 3- 1/2LB COIL	100	EA	14384110E
3	0000004523	WIRE COP BARE MHD SOLID # 6 25LB/315/FT	20	EA	14384110E
4	0000007469	ROD GROUND 5/8 IN X 8 FT COPPERWELD EL230	2	EA	14384110E
5	0000017302	CLAMP GROUND VISE TYPE FOR 5/8 GROUND ROD CAST BRONZE	4	EA	14384110E
6	0000001402	CONCRETE 5 SACK CLASS A	6.5	EA	14384110E

SWTGRVISTA6WAY600-900AW 14384110W PDMT SWTGR VISTA 6-WAY 600 - 900A W

ID	PART NUM	PART DESC	QTY		CU-REF
1	0000001295	STEEL ROUND REINF GRADE 60 #3 X 20 FT LENGTH	10	EA	14384110W
2	0000009487	WIRE STEEL BLACK # 16 3- 1/2LB COIL	100	EA	14384110W
3	0000004523	WIRE COP BARE MHD SOLID # 6 25LB/315/FT	20	EA	14384110W
4	0000007469	ROD GROUND 5/8 IN X 8 FT COPPERWELD EL230	2	EA	14384110W
5	0000017302	CLAMP GROUND VISE TYPE FOR 5/8 GROUND ROD CAST BRONZE	4	EA	14384110W
6	0000001402	CONCRETE 5 SACK CLASS A	6.5	EA	14384110W

FOR DETAILS	SEE PAGE
BARRIER POSTS AND CLEARANCE	1438- 10
STRUCTURE GROUNDING	1488- 10 AND 1488- 20

1438-43	CIVIL	PADS, CLEARANCES AND BARRIERS NOTES FOR PME ATO SWITCHGEAR PAD	
Sheet 1 of 1			
Rev: 08/01/20			

PME ATO SWITCHGEAR PAD NOTES:

1. **GROUND ROD DETAIL 1488-10 (PREFERRED)**
THE GROUND ROD SHALL BE INSTALLED AS PER SECTION 1488-10. THE GROUND ROD SHALL BE INSTALLED NO LESS THAN 4" AND NO GREATER THAN 6" ABOVE THE PAD SURFACE. WHEN A BURIED GROUND ELECTRODE IS INSTALLED, A 2/0 AWG STRANDED BARE SOFT DRAWN TINNED COPPER WIRE SHALL BE BONDED TO THE GROUND ROD WITH A MINIMUM 12" TAIL EXPOSED ABOVE THE FINISHED CONCRETE PAD SURFACE. THE GROUND ROD SHALL BE 5/8" X 8' COPPER CLAD.

GROUND WIRE DETAIL 1488-20 (OPTIONAL)
IN CONDITIONS WHERE THE INSTALLATION OF A GROUND ROD IS NOT FEASIBLE, 35' OF 2/0 AWG STRANDED BARE SOFT DRAWN TINNED COPPER WIRE ENCASED BY A 2" CONCRETE ENVELOPE SHALL BE INSTALLED AS PER SECTION 1488-20. A 2/0 AWG STRANDED BARE SOFT DRAWN TINNED COPPER WIRE SHALL BE BONDED TO THE 2/0 GROUND WIRE WITH A MINIMUM 12" TAIL EXPOSED ABOVE FINISHED CONCRETE PAD SURFACE.
2. STEEL BARRIER POST WILL BE REQUIRED WHENEVER SWITCHGEAR PAD IS INSTALLED WITHIN 4' OF A TRAFFIC AREA. SEE BARRIER POST DETAIL DRAWING FOR CONSTRUCTION DETAILS AND CLEARANCE REQUIREMENTS.
3. COMPACT SOIL UNDER PADS TO AT LEAST 95% COMPACTION PRIOR TO INSTALLING PADS. AUSTIN ENERGY MUST INSPECT PAD AND APPROVE PRIOR TO POURING ANY CONCRETE.
4. CONCRETE SHALL CONFORM TO ASTM C-150 AND SHALL HAVE A COMPRESSIVE STRENGTH OF 3000 LBS AT 28 DAYS. CONCRETE SLUMP SHALL BE NO MORE THAN 4-IN. MAXIMUM AGGREGATE SIZE SHALL NOT EXCEED 1-1/2 INCHES. REINFORCING RODS SHALL BE INTERMEDIATE GRADE (GRADE 60) AND SHALL CONFORM TO ASTM-615.
5. 90 ° (MIN 24" RADIUS) CONDUIT BEND BE COMPLETELY CONCRETE ENCASED.
6. BELL ENDS SHALL BE 1" ABOVE PAD.
7. 5" CONDUITS FOR LINE SIDE AND 5" CONDUITS OR SMALLER FOR LOAD SIDE MAY BE USED.
8. 4" COMMS CONDUITS FOR COMMUNICATIONS SHALL BE 15" ABOVE SLAB.

1438-44
Sheet 1 of 2
Rev: 08/01/20

CIVIL
PADS, CLEARANCES AND BARRIERS
PAD PME ATO SWITCHGEAR

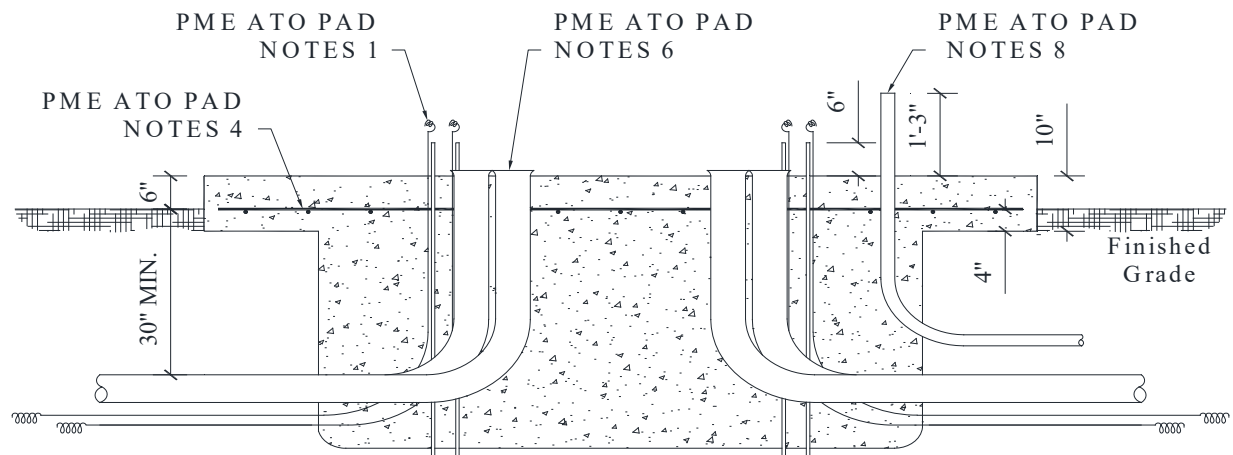
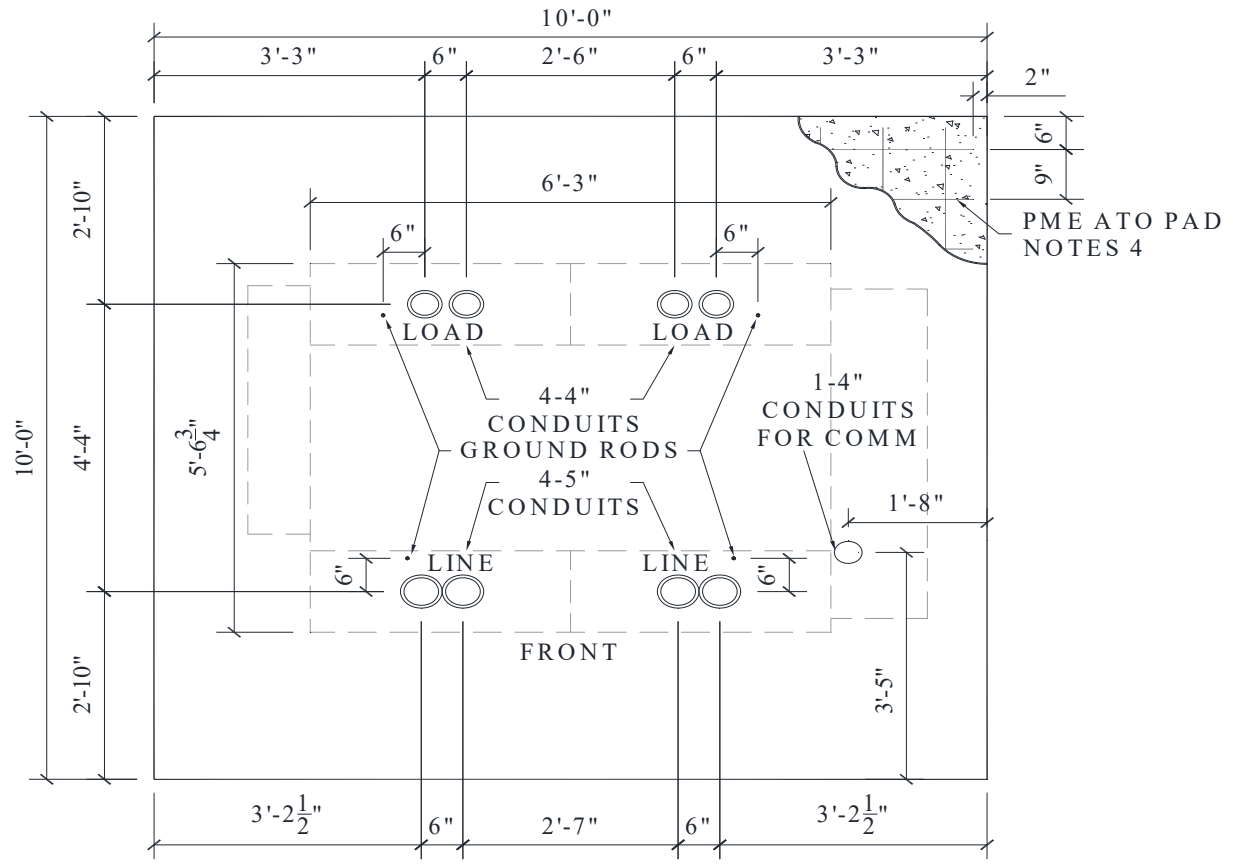

REFER TO PME ATO PAD DETAIL NOTES ON SECTION 1438-43 FOR DETAILS ON PME ATO SWITCHGEAR CONCRETE PAD CONSTRUCTION.

1438-44	CIVIL	PADS, CLEARANCES AND BARRIERS PAD PME ATO SWITCHGEAR	
Sheet 2 of 2			
Rev: 08/01/20			

CU

CU-ID	CU-REF	CU-DESCRIPTION
--------------	---------------	-----------------------

SWTGRATOPMEE	14384410E	PDMT SWGR ATO PME EAST
--------------	-----------	------------------------

ID	PART NUM	PART DESC	QTY	EA	CU-REF
1	0000001295	STEEL ROUND REINF GRADE 60 #3 X 20 FT LENGTH	10	EA	14384410E
2	0000009487	WIRE STEEL BLACK # 16 3-1/2LB COIL	100	EA	14384410E
3	0000001211	CABLE BARE STRD COP TINNED SOFT 2/0 AWG	5	EA	14384410E
4	0000007469	ROD GROUND 5/8 IN X 8 FT COPPERWELD EL230	4	EA	14384410E
5	0000017302	CLAMP GROUND VISE TYPE FOR 5/8 GROUND ROD CAST BRONZE	4	EA	14384410E
6	0000001402	CONCRETE 5 SACK CLASS A	6.5	EA	14384410E

SWTGRATOPMEW	14384410W	PDMT SWGR ATO PME WEST
--------------	-----------	------------------------

ID	PART NUM	PART DESC	QTY	EA	CU-REF
1	0000001295	STEEL ROUND REINF GRADE 60 #3 X 20 FT LENGTH	10	EA	14384410W
2	0000009487	WIRE STEEL BLACK # 16 3-1/2LB COIL	100	EA	14384410W
3	0000001211	CABLE BARE STRD COP TINNED SOFT 2/0 AWG	140	EA	14384410W
4	0000006806	CONNECTOR SPLIT BOLT #6 SOLID COP	4	EA	14384410W
5	0000001402	CONCRETE 5 SACK CLASS A	6.5	EA	14384410W

FOR DETAILS	SEE PAGE
BARRIER POSTS AND CLEARANCE	1438- 10
STRUCTURE GROUNDING	1488- 10 AND 1488- 20

1438-46	CIVIL	PADS, CLEARANCES AND BARRIERS NOTES FOR DBL TANK ATO SWITCHGEAR PAD	
Sheet 1 of 2			
Rev: 08/01/20			

DOUBLE TANK ATO SWITCHGEAR PAD NOTES:

1. **GROUND ROD DETAIL 1488-10 (PREFERRED)**
THE GROUND ROD SHALL BE INSTALLED AS PER SECTION 1488-10. THE GROUND ROD SHALL BE INSTALLED NO LESS THAN 4" AND NO GREATER THAN 6" ABOVE THE PAD SURFACE. WHEN A BURIED GROUND ELECTRODE IS INSTALLED, A 2/0 AWG STRANDED BARE SOFT DRAWN TINNED COPPER WIRE SHALL BE BONDED TO THE GROUND ROD WITH A MINIMUM 12" TAIL EXPOSED ABOVE THE FINISHED CONCRETE PAD SURFACE. THE GROUND ROD SHALL BE 5/8" X 8' COPPER CLAD.

GROUND WIRE DETAIL 1488-20 (OPTIONAL)
IN CONDITIONS WHERE THE INSTALLATION OF A GROUND ROD IS NOT FEASIBLE, 35' OF 2/0 AWG STRANDED BARE SOFT DRAWN TINNED COPPER WIRE ENCASED BY A 2" CONCRETE ENVELOPE SHALL BE INSTALLED AS PER SECTION 1488-20. A 2/0 AWG STRANDED BARE SOFT DRAWN TINNED COPPER WIRE SHALL BE BONDED TO THE 2/0 GROUND WIRE WITH A MINIMUM 12" TAIL EXPOSED ABOVE FINISHED CONCRETE PAD SURFACE.
2. STEEL BARRIER POST WILL BE REQUIRED WHENEVER SWITCHGEAR PAD IS INSTALLED WITHIN 4' OF A TRAFFIC AREA. SEE BARRIER POST DETAIL DRAWING FOR CONSTRUCTION DETAILS AND CLEARANCE REQUIREMENTS.
3. COMPACT SOIL UNDER PADS TO AT LEAST 95% COMPACTION PRIOR TO INSTALLING PADS. AUSTIN ENERGY MUST INSPECT PAD AND APPROVE PRIOR TO POURING ANY CONCRETE.
4. CONCRETE SHALL CONFORM TO ASTM C-150 AND SHALL HAVE A COMPRESSIVE STRENGTH OF 3000 LBS AT 28 DAYS. CONCRETE SLUMP SHALL BE NO MORE THAN 4-IN. MAXIMUM AGGREGATE SIZE SHALL NOT EXCEED 1-1/2 INCHES. REINFORCING RODS SHALL BE INTERMEDIATE GRADE (GRADE 60) AND SHALL CONFORM TO ASTM-615.
5. 90 ° (MIN 24" RADIUS) CONDUIT BEND BE COMPLETELY CONCRETE ENCASED.
6. BELL ENDS SHALL BE 1" ABOVE PAD.
7. 5" CONDUITS FOR LINE SIDE AND 5" CONDUITS OR SMALLER FOR LOAD SIDE MAY BE USED.
8. 4" CONDUITS FOR COMMUNICATIONS SHALL BE USED. IF A COMMUNICATION RISER POLE IS REQUIRED FOR COMMUNICATIONS, THE CUSTOMER WILL BE RESPONSIBLE FOR INSTALLING THIS. FOR DETAILS ON THE COMMUNICATION RISER POLE CONSTRUCTION REFER TO SECTION 1360-70.

1438-47
Sheet 1 of 2
Rev: 08/01/20

CIVIL
PADS, CLEARANCES AND BARRIERS
PAD PME DOUBLE TANK ATO SWITCHGEAR

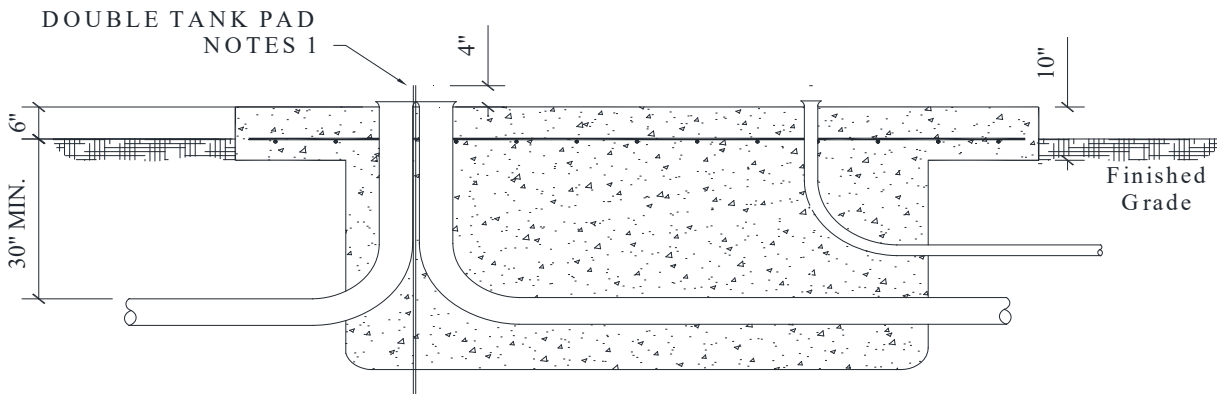
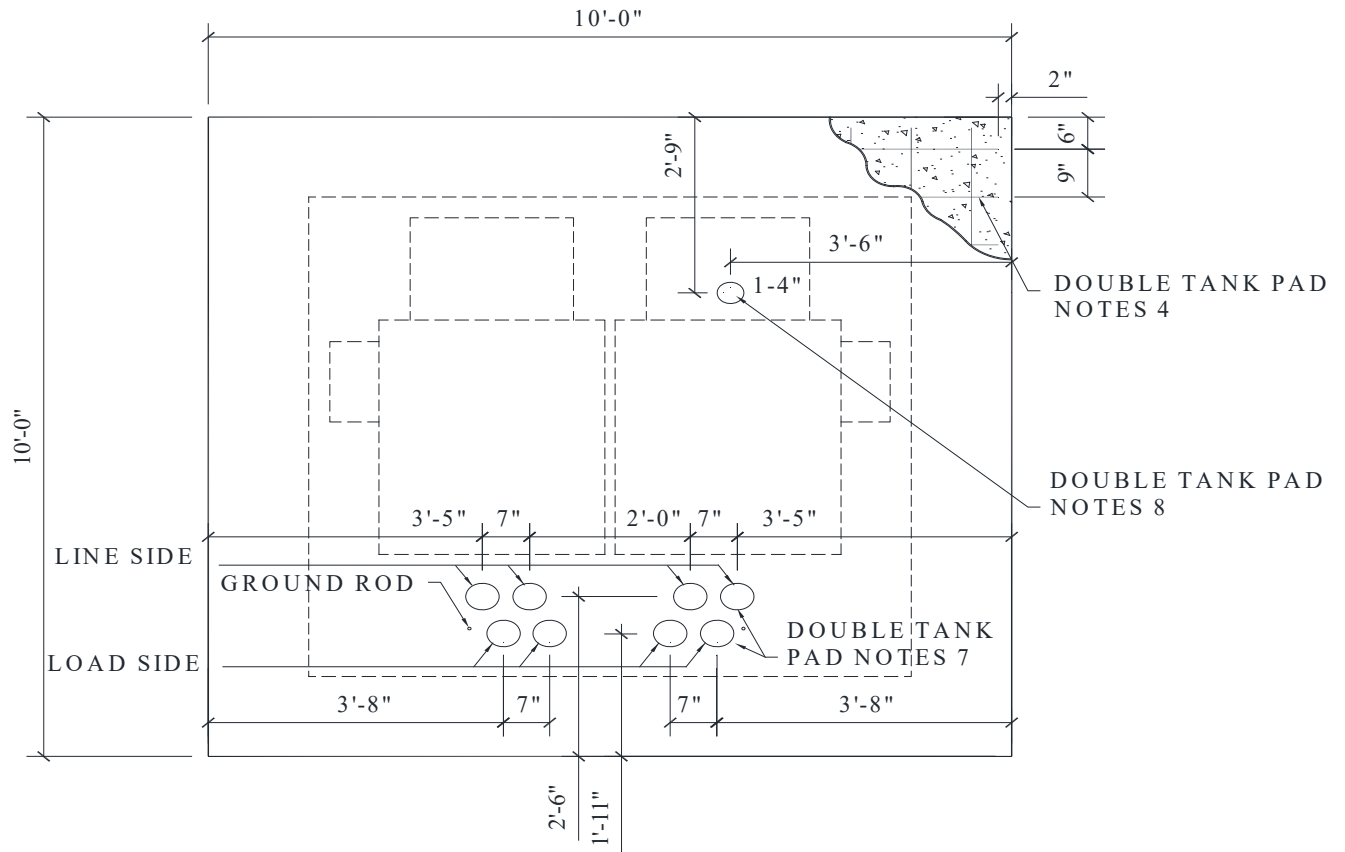

REFER TO DOUBLE TANK ATO PAD DETAIL NOTES ON SECTION 1438-46 FOR DETAILS ON DOUBLE ATO SWITCHGEAR CONCRETE PAD CONSTRUCTION.

1438-47	CIVIL PADS, CLEARANCES AND BARRIERS PAD PME DOUBLE TANK ATO SWITCHGEAR	
Sheet 2 of 2		
Rev: 08/01/20		

CU

CU-ID	CU-REF	CU-DESCRIPTION
--------------	---------------	-----------------------

SWTGRATODBLTANKE	14384710E	PDMT SWGR ATO DOUBLE TANK EAST
------------------	-----------	--------------------------------

ID	PART NUM	PART DESC	QTY	EA	CU-REF
1	0000001295	STEEL ROUND REINF GRADE 60 #3 X 20 FT LENGTH	10	EA	14384710E
2	0000009487	WIRE STEEL BLACK # 16 3- 1/2LB COIL	100	EA	14384710E
3	0000001211	CABLE BARE STRD COP TINNED SOFT 2/0 AWG	5	EA	14384710E
4	0000007469	ROD GROUND 5/8 IN X 8 FT COPPERWELD EL230	2	EA	14384710E
5	0000017302	CLAMP GROUND VISE TYPE FOR 5/8 GROUND ROD CAST BRONZE	2	EA	14384710E
6	0000001402	CONCRETE 5 SACK CLASS A	6.5	EA	14384710E

SWTGRATODBLTANKW	14384710W	PDMT SWGR ATO DOUBLE TANK WEST
------------------	-----------	--------------------------------

ID	PART NUM	PART DESC	QTY	EA	CU-REF
1	0000001295	STEEL ROUND REINF GRADE 60 #3 X 20 FT LENGTH	10	EA	14384710W
2	0000009487	WIRE STEEL BLACK # 16 3- 1/2LB COIL	100	EA	14384710W
3	0000001211	CABLE BARE STRD COP TINNED SOFT 2/0 AWG	40	EA	14384710W
4	0000006806	CONNECTOR SPLIT BOLT #6 SOLID COP	2	EA	14384710W
5	0000001402	CONCRETE 5 SACK CLASS A	6.5	EA	14384710W

FOR DETAILS	SEE PAGE
BARRIER POSTS AND CLEARANCE	1438- 10
STRUCTURE GROUNDING	1488- 10 AND 1488- 20

1438-48
Sheet 1 of 2
Rev: 08/01/20

CIVIL
PADS, CLEARANCES AND BARRIERS
PAD PREFORMED TEMP XFMR (25-167KVA)

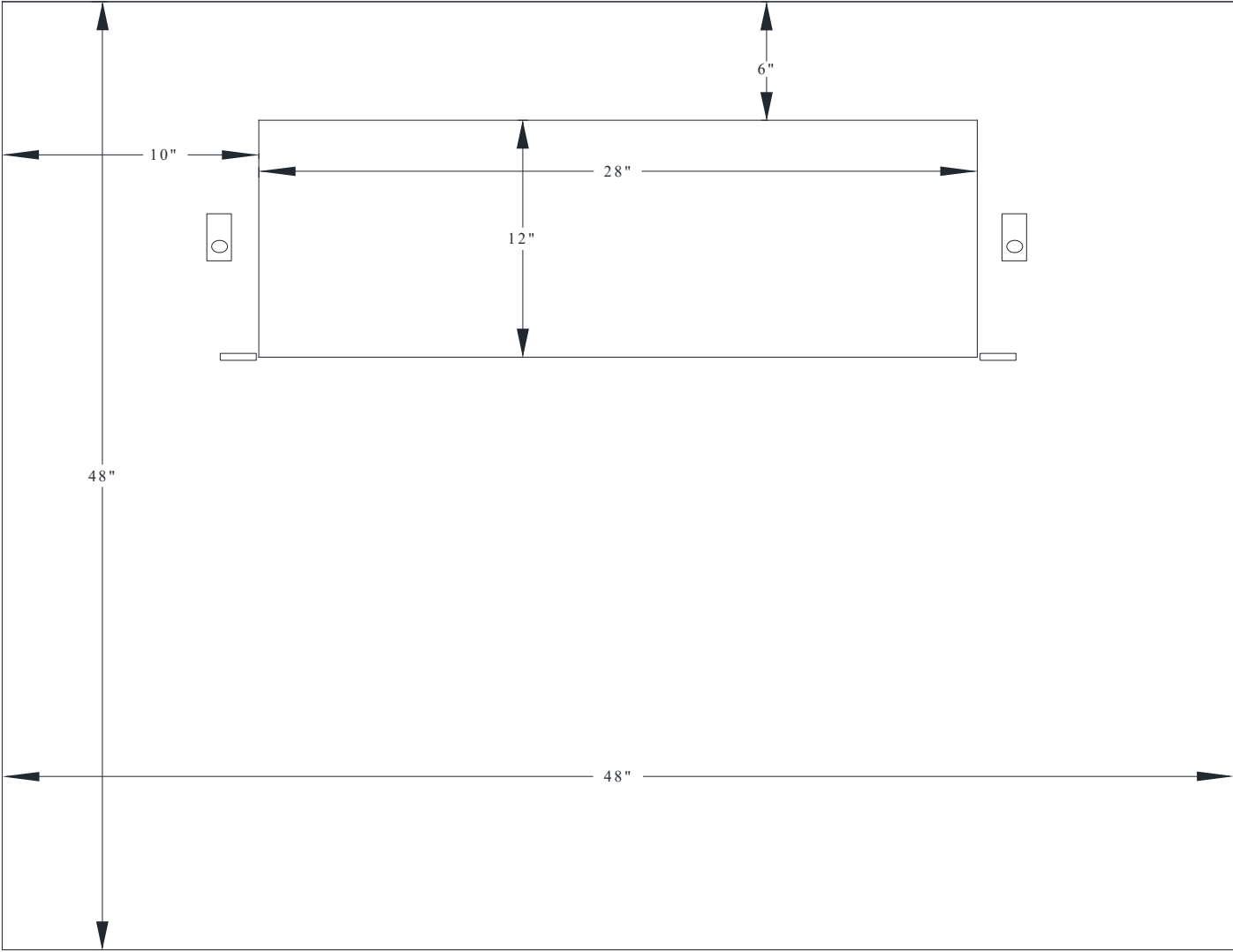

1438-48	CIVIL	PADS, CLEARANCES AND BARRIERS PAD PREFORMED TEMP XFMR (25-167KVA)	
Sheet 2 of 2			
Rev: 08/01/20			

CU

CU-ID	CU-REF	CU-DESCRIPTION
--------------	---------------	-----------------------

PADMTTEMPXFRMR25-167KVA	14384801	PAD MOUNT TEMPORARY XFRMR PAD 25-167 KVA
-------------------------	----------	--

ID	PART NUM	PART DESC	QTY	CU-REF
1	0000000275	PAD PREFORMED PLYMR CONCRETE PADMT XFMR 25KVA - 167KVA	1 EA	14384801

1438-55	CIVIL	
Sheet 1 of 1	PADS, CLEARANCES AND BARRIERS	
Rev: 08/01/20	PAD CIP 1PH XFMR 5FT X 5FT (25-167KVA)	

GENERAL NOTES FOR CONCRETE PADS FOR SINGLE AND 3 PHASE PAD-MOUNTED TRANSFORMERS:

1. FOR SHELL BUILDINGS, STUB ALL SPARE CONDUITS AT THE BUILDINGS SERVICE RISER.
2. ALL UNUSED SPARE CONDUITS SHALL BE STUBBED 5 FEET BEYOND THE EDGE OF THE PAD.
3. GROUND ROD DETAIL 1488-10 (PREFERRED)
 THE GROUND ROD SHALL BE INSTALLED AS PER SECTION 1488-10. THE GROUND ROD SHALL BE INSTALLED ON THE SECONDARY SIDE OF THE TRANSFORMER PAD. THE GROUND ROD SHALL BE INSTALLED NO LESS THAN 4" AND NO GREATER THAN 6" ABOVE THE PAD SURFACE. WHEN A BURIED GROUND ELECTRODE IS INSTALLED, A 2/0 AWG STRANDED BARE SOFT DRAWN TINNED COPPER WIRE SHALL BE BONDED TO THE GROUND ROD WITH A MINIMUM 12" TAIL EXPOSED ABOVE THE FINISHED CONCRETE PAD SURFACE. THE GROUND ROD SHALL BE 5/8" X 8' COPPER CLAD.

 GROUND WIRE DETAIL 1488-20 (OPTIONAL)
 IN CONDITIONS WHERE THE INSTALLATION OF A GROUND ROD IS NOT FEASIBLE, 35' OF 2/0 AWG STRANDED BARE SOFT DRAWN TINNED COPPER WIRE ENCASED BY A 2" CONCRETE ENVELOPE SHALL BE INSTALLED AS PER SECTION 1488-20. A 2/0 AWG STRANDED BARE SOFT DRAWN TINNED COPPER WIRE SHALL BE BONDED TO THE 2/0 GROUND WIRE WITH A MINIMUM 12" TAIL EXPOSED ABOVE FINISHED CONCRETE PAD SURFACE.
4. STEEL BARRIER POSTS WILL BE REQUIRED WHENEVER TRANSFORMER PAD IS INSTALLED WITHIN 4' OF A TRAFFIC AREA. SEE BARRIER POST DETAIL DRAWING 1438-10, FOR CONSTRUCTION DETAILS AND CLEARANCE REQUIREMENTS.
5. COMPACT SOIL BENEATH PADS TO AT LEAST 95% COMPACTION, PRIOR TO INSTALLING PADS. AUSTIN ENERGY MUST INSPECT PAD AND APPROVE PRIOR TO POURING ANY CONCRETE.
6. CONCRETE SHALL CONFORM TO ASTM C-150 AND SHALL HAVE A COMPRESSIVE STRENGTH OF 3000 LBS AT 28 DAYS. CONCRETE SLUMP SHALL BE NO MORE THAN 4-IN. MAXIMUM AGGREGATE SHALL NOT EXCEED 1-1/2 IN. REINFORCING RODS SHALL BE INTERMEDIATE GRADE (GRADE 60) AND SHALL CONFORM TO ASTM A-615.
7. GRADE AREA AROUND THE PAD, SO THAT DRAINAGE IS ALWAYS AWAY FROM THE PAD. RETAINING WALLS AND DRAINAGE CHANNELS MAY BE REQUESTED BY THE UTILITY, TO PREVENT WATER AND DEBRIS FROM ACCUMULATING ON THE ROAD.
8. 90° (MIN. 24" RADIUS) CONDUIT BEND SHALL BE COMPLETELY CONCRETE ENCASED.
9. INSTALL #6 BARE COPPER WIRE 6" BELOW FINISHED GRADE FOR TELECO. LEAVE 12" EXPOSED ABOVE PAD TO BE CONNECTED TO GROUND ROD (OR GROUND WIRE, WHICHEVER METHOD IS USED) WHEN CONNECTIONS ARE MADE IN THE TRANSFORMER.
10. BELL ENDS SHALL BE 1" ABOVE PAD.

1438-60
Sheet 1 of 1
Rev: 08/01/20

CIVIL
PADS, CLEARANCES AND BARRIERS
PAD CIP 1PH XFMR 5FT X 5FT (25-250KVA)

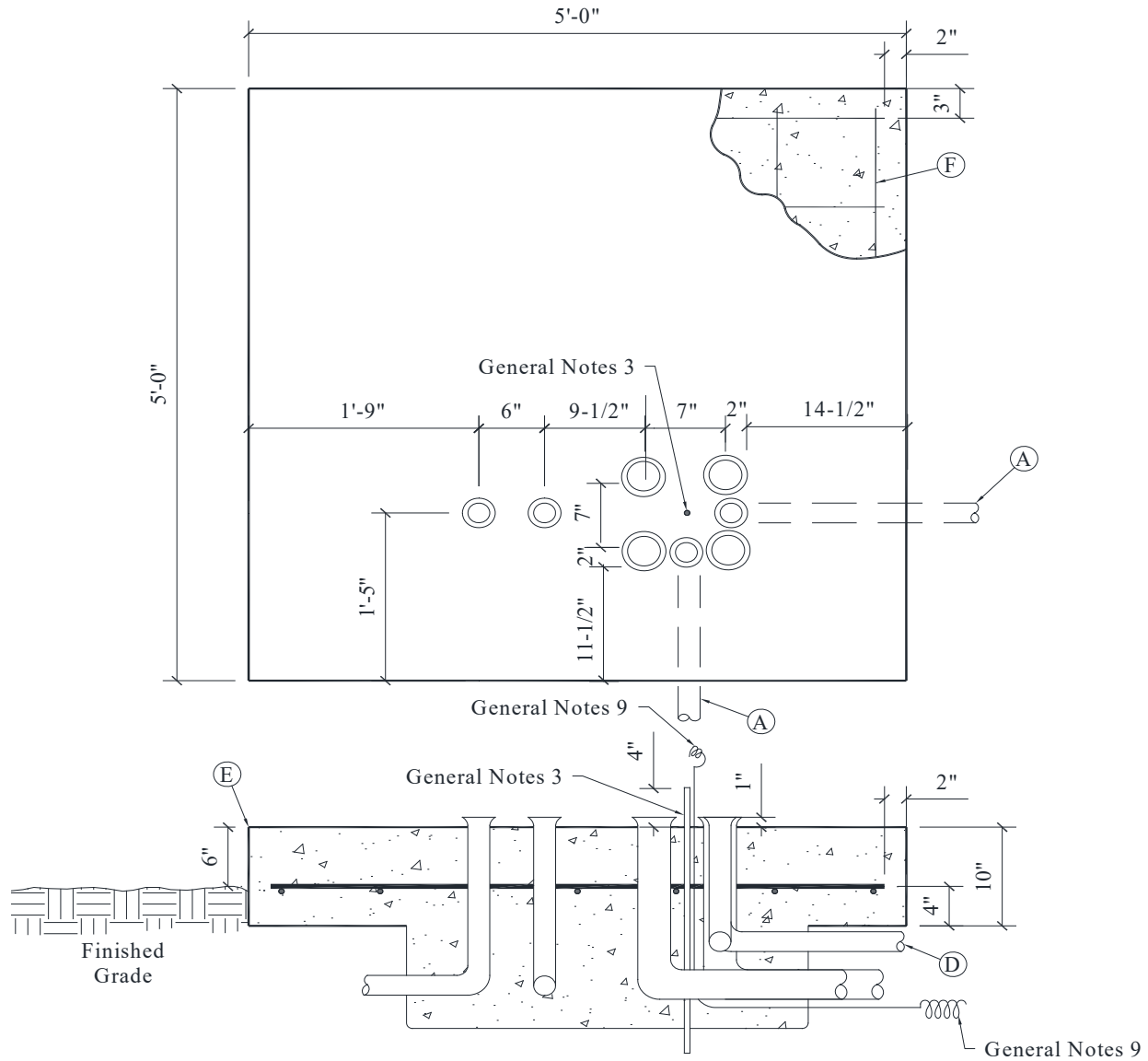
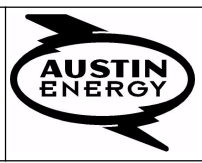

NOTES:

- A. ALL CONDUITS SHALL BE INSTALLED IN ACCORDANCE WITH THE ABOVE DRAWING.
 2-2" PRIMARY CONDUITS SHALL BE INSTALLED WITH BELL ENDS 1" ABOVE FINISHED CONCRETE PAD.
 4-3" SECONDARY CONDUITS MAXIMUM CAN BE INSTALLED WITH BELL ENDS 1" ABOVE FINISHED CONCRETE PAD.
 1-2" STREETLIGHT CONDUIT SHALL BE INSTALLED WITH BELL ENDS 1" ABOVE FINISHED GRADE, 2' BEYOND THE THE EDGE OF THE PAD ON THE STREET SIDE WHEN SPACE PERMITS.
 1-2" CONSTRUCTION LOOP CONDUIT SHALL BE INSTALLED WITH BELL ENDS 1" ABOVE FINISHED GRADE.
- B. ALL CONSTRUCTION LOOP CONDUITS SHALL BE INSTALLED ON THE RIGHT SIDE OF THE PAD.
- C. THE CONDUIT DIRECTION SHALL BE SPECIFIED ON AUSTIN ENERGY APPROVED CONSTRUCTION PRINTS.
- D. IF MORE THAN 3-3" CONDUITS ARE REQUIRED FOR THE INSTALLATION OF THE CUSTOMERS SERVICE ENTRANCE CONDUCTORS, THE CUSTOMER SHALL BE REQUIRED TO FURNISH A SPECIAL CABLE TERMINATION ENCLOSURE.
- E. TOP OF PAD SHALL BE 6" ABOVE FINAL GRADE.
- F. #3 REINFORCED STEEL 9" ON CENTER AND 4" ABOVE BOTTOM OF PAD.
- G. REFER TO GENERAL NOTES IN SECTION 1438-55 FOR DETAILS ON TRANSFORMER CONCRETE PAD CONSTRUCTION.

1438-90
Sheet 1 of 2
Rev: 07/25/23

CIVIL
PADS, CLEARANCES AND BARRIERS
PAD CIP 3PH XFMR 10FT X 10FT (75-2500KVA)

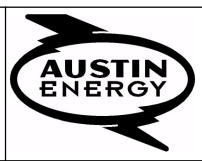

TOP SLAB CONCRETE SHALL CONFORM TO ASTM C-150 AND SHALL HAVE A COMPRESSIVE STRENGTH OF 3000 LBS. AT 28 DAYS. CONCRETE SLUMP SHALL BE NO MORE THAN 4-IN. MAXIMUM AGGREGATE SIZE SHALL NOT EXCEED 1-1/2 IN. REINFORCING RODS SHALL BE INTERMEDIATE GRADE (GRADE 60) AND SHALL CONFORM TO ASTM A-615.

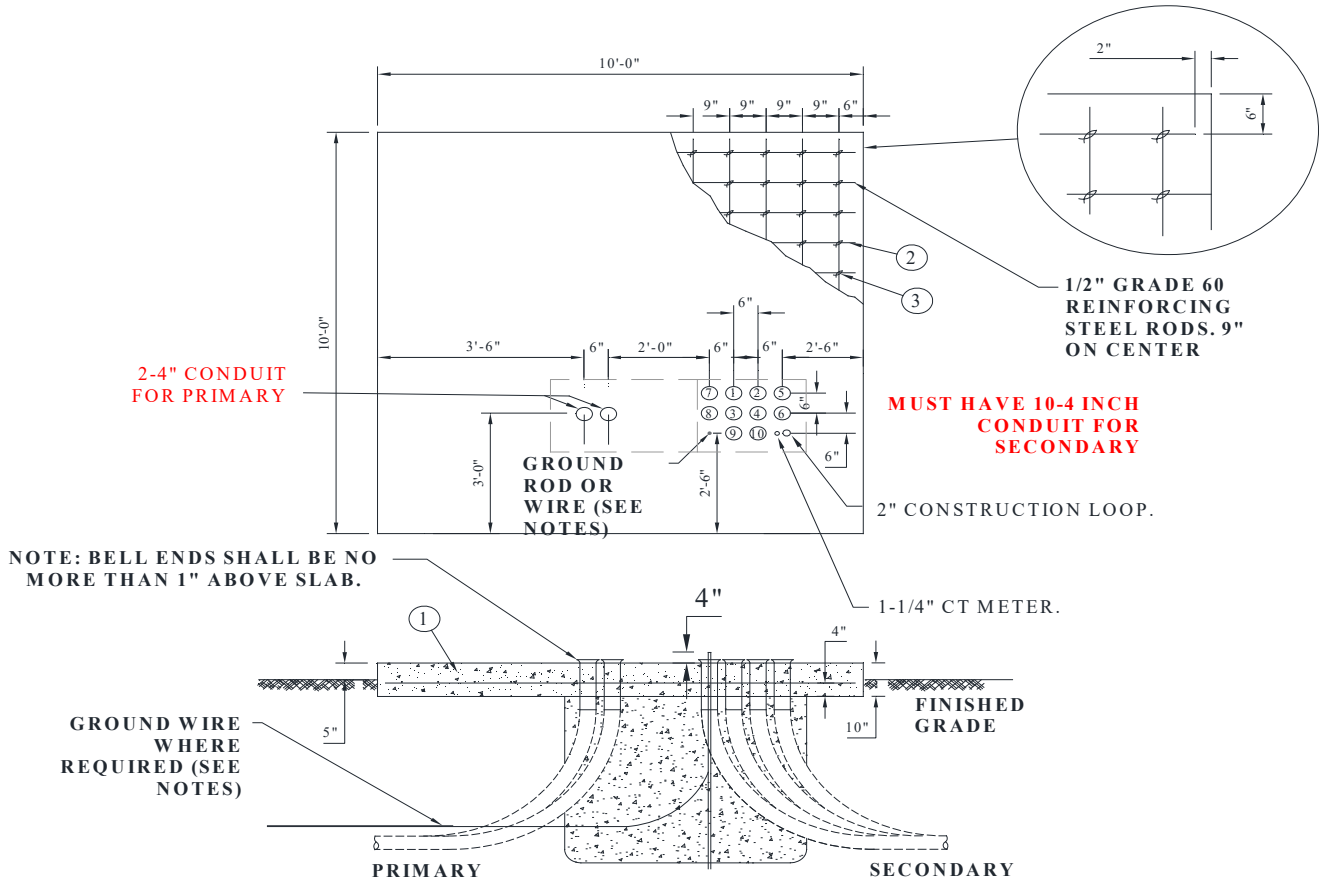

BOTTOM SLAB CONCRETE SHALL BE 4 SACK AND CONFORM TO ASTM C-150 AND SHALL HAVE A COMPRESSIVE STRENGTH OF 2000 LBS. AT 28 DAYS. MAXIMUM AGGREGATE SIZE SHALL NOT EXCEED 3/8 IN. REINFORCING RODS SHALL BE INTERMEDIATE GRADE (GRADE 60) AND SHALL CONFORM TO ASTM A-615.

- NOTES:**
1. A MAXIMUM OF 2-4-INCH OR 2-5-INCH CONDUITS ON THE PRIMARY SIDE. SECONDARY SIDE MUST HAVE 10-4-INCH CONDUITS AND A MAXIMUM OF 10 SETS OF CABLE PER PHASE CAN BE INSTALLED IN THE ARRANGEMENT AND NUMERICAL ORDERED AS SHOWN, WITH 1-2-INCH TEMP LOOP CONDUIT, AND 1-1 1/4-INCH CT CONDUIT..
 2. FOR SHELL BUILDINGS, STUB ALL SPARE CONDUITS AT THE BUILDING SERVICE RISER.
 3. 35' OF 2/0 STRANDED BARE SOFT-DRAWN, TINNED COPPER GROUND OR 5/8"x8' CU. COPPERWELD GROUND ROD. (SEE GROUNDING DETAIL 1488-10 OR 1488-20)
 4. STEEL BARRIER POSTS WILL BE REQUIRED WHENEVER LOAD BREAK SECTIONALIZING CABINET IS PAD INSTALLED WITHIN 4' OF A TRAFFIC AREA. (SEE BARRIER POST DETAIL DRAWING 1400-10, FOR CONSTRUCTION DETAILS AND CLEARANCE REQUIREMENTS.)
 5. COMPACT SOIL BENEATH PADS TO AT LEAST 95% COMPACTION, PRIOR TO INSTALLING PADS. AUSTIN ENERGY MUST INSPECT PAD AND APPROVE PRIOR TO POURING ANY CONCRETE.
 6. GRADE AREA AROUND THE PAD, SO THAT DRAINAGE IS ALWAYS AWAY FROM THE PAD. RETAINING WALLS AND DRAINAGE CHANNELS MAY BE REQUESTED BY THE UTILITY, TO PREVENT WATER AND DEBRIS FROM ACCUMULATING ON THE ROAD.
 7. 90° (MIN. 24" RADIUS) CONDUIT BEND SHALL BE COMPLETELY CONCRETE ENCASED.
 8. BELL ENDS SHALL BE 1" ABOVE SLAB.

1438-90	CIVIL PADS, CLEARANCES AND BARRIERS PAD CIP 3PH XFMR 10FT X 10FT (75- 2500KVA)	
Sheet 2 of 2		
Rev: 08/01/20		

CU

CU- ID CU- REF CU-DESCRIPTION

PADCIP3PHXF10X10E 14389010E PAD CIP 3PH XFMR 10'X10' EAST

ID	PART NUM	PART DESC	QTY		CU-REF
1	0000001295	STEEL ROUND REINF GRADE 60 #3 X 20 FT LENGTH	2	EA	14386010E
6	0000001402	CONCRETE 5 SACK CLASS A	3	EA	14386010E
3	0000004523	WIRE COP BARE MHD SOLID # 6 25LB/315/FT	10	EA	14386010E
4	0000007469	ROD GROUND 5/8 IN X 8 FT COPPERWELD EL230	1	EA	14386010E
2	0000009487	WIRE STEEL BLACK # 16 3- 1/2LB COIL	20	EA	14386010E
5	0000017302	CLAMP GROUND VISE TYPE FOR 5/8 GROUND ROD CAST BRONZE	2	EA	14386010E

PADCIP3PHXF10X10W 14389010W PAD CIP 3PH XFMR 10'X10' WEST

ID	PART NUM	PART DESC	QTY		CU-REF
1	0000001295	STEEL ROUND REINF GRADE 60 #3 X 20 FT LENGTH	2	EA	14386010W
5	0000001402	CONCRETE 5 SACK CLASS A	3	EA	14386010W
3	0000004523	WIRE COP BARE MHD SOLID # 6 25LB/315/FT	10	EA	14386010W
4	0000006806	CONNECTOR SPLIT BOLT #6 SOLID COP	1	EA	14386010W
2	0000009487	WIRE STEEL BLACK # 16 3- 1/2LB COIL	20	EA	14386010W

FOR DETAILS	SEE PAGE
BARRIER POSTS AND CLEARANCE	1438- 10
STRUCTURE GROUNDING	1488- 10 AND 1488- 20

1438-95
Sheet 1 of 2
Rev: 08/01/20

CIVIL
PADS, CLEARANCES AND BARRIERS
15 INCH PAD FOR URD-METER PEDESTAL

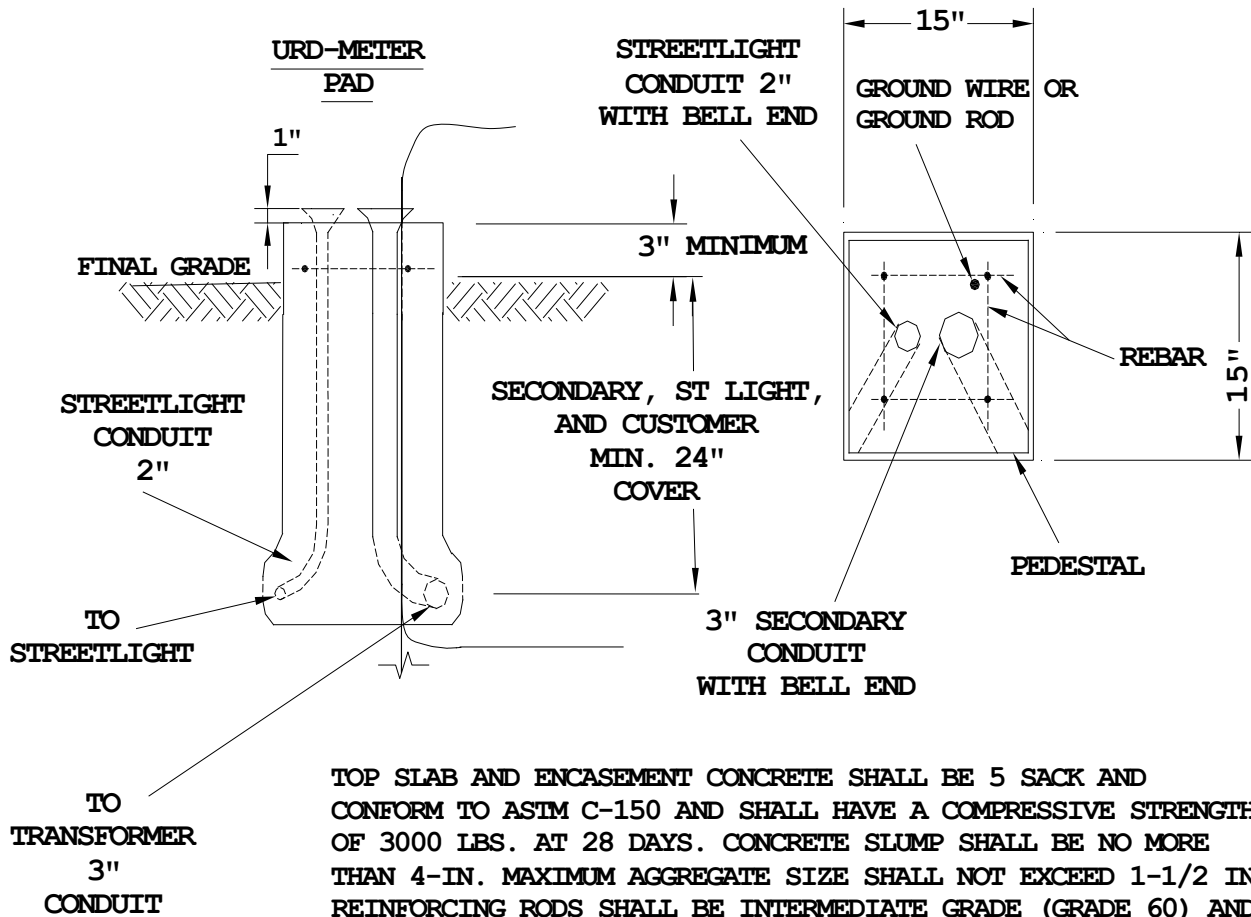

TOP SLAB AND ENCASEMENT CONCRETE SHALL BE 5 SACK AND CONFORM TO ASTM C-150 AND SHALL HAVE A COMPRESSIVE STRENGTH OF 3000 LBS. AT 28 DAYS. CONCRETE SLUMP SHALL BE NO MORE THAN 4-IN. MAXIMUM AGGREGATE SIZE SHALL NOT EXCEED 1-1/2 IN. REINFORCING RODS SHALL BE INTERMEDIATE GRADE (GRADE 60) AND SHALL CONFORM TO ASTM A-615.

NOTES: METER PAD

1. COPPERWELD GROUND ROD (8 FT-0 IN) OR 35 FT OF 2/0 STRANDED BARE SOFT DRAWN, TINNED. (SEE GROUNDING DETAIL 1488-10 AND 1488-20)
2. CONDUIT ENCASEMENT CONCRETE SHALL BE A DEPTH OF 24 IN MINIMUM. THE 3 IN AND 2 IN ELBOW MUST BE ENTIRELY ENCASED IN CONCRETE.
3. THE REINFORCING BARS SHALL BE PLACED 2 IN BELOW TOP OF CONCRETE. THE BAR SPACING SHALL BE 6 IN MINIMUM TO 8 IN MAXIMUM. THE BAR SIZE SHALL BE #3.
4. GRADE AREA AROUND PAD SO THAT DRAINAGE IS ALWAYS AWAY FROM THE PAD.
5. LOCATION OF PAD WILL BE DETERMINED BY AE DESIGNER.
6. CONDUIT SHALL BE SCHEDULE 40.
7. 3 IN CONDUIT AND 2 IN CONDUIT SHALL HAVE A BELL END EXTENDED 1 IN ABOVE SLAB.
8. ARRANGE CONDUIT SUCH THAT THE 3 IN IS ON THE PADMOUNT TRANSFORMER SIDE OF THE PEDESTAL.

1438-96
Sheet 1 of 1
Rev: 08/01/20

CIVIL
PADS, CLEARANCES AND BARRIERS
METER PAD AND PEDESTAL ASSEMBLY

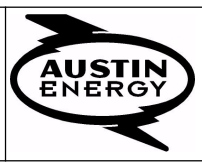

NOTES:

1. PEDESTAL MUST BE CENTERED ON THE PAD.
2. MOUNTING HARDWARE WILL CONSIST OF TWO (2) HOLD DOWN BOLTS OPPOSITE EACH OTHER LOCATED ON THE METER SIDES OF THE PEDESTAL.

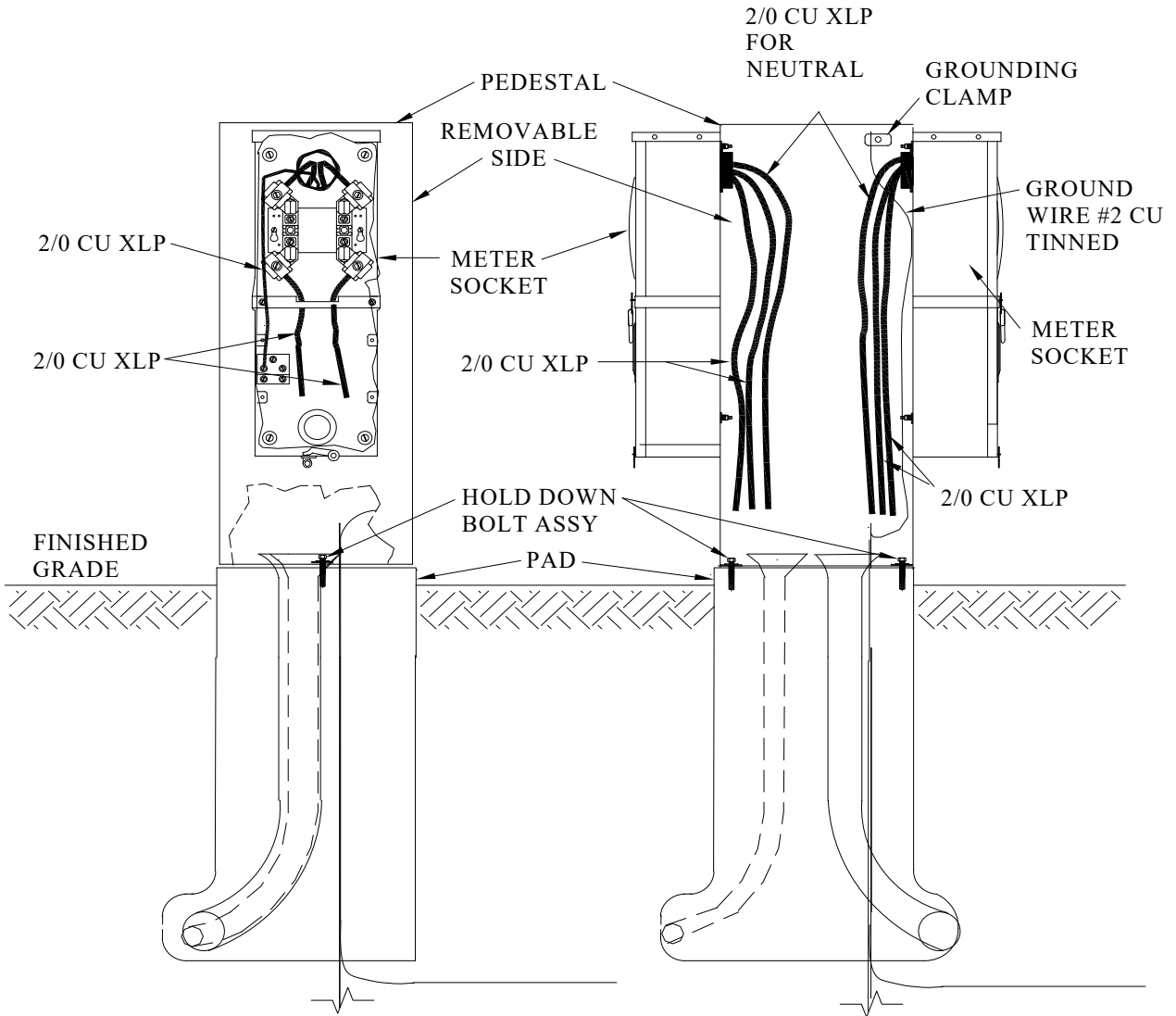

1438-97
Sheet 1 of 3
Rev: 08/01/20

CIVIL
PADS, CLEARANCES AND BARRIERS
PEDESTAL ASSEMBLIES POSITIONING

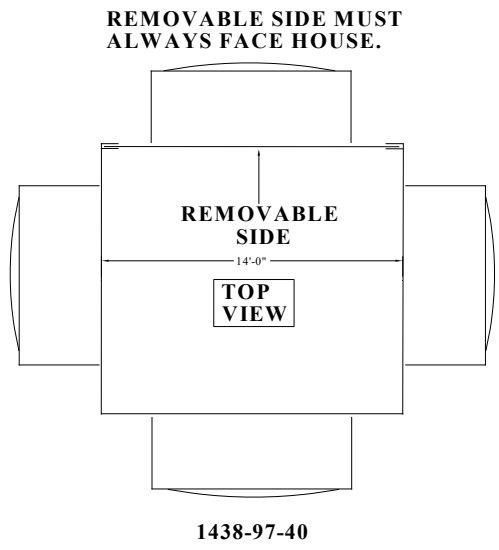
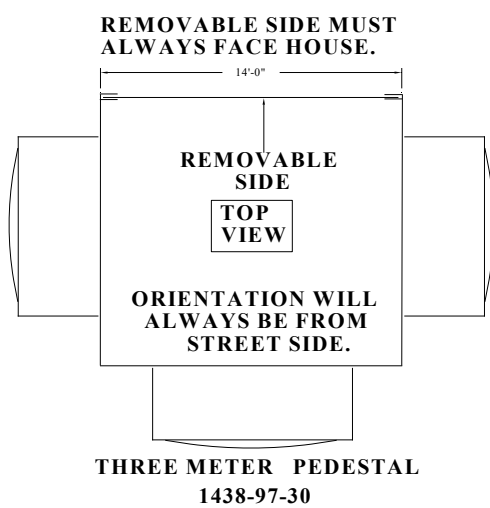
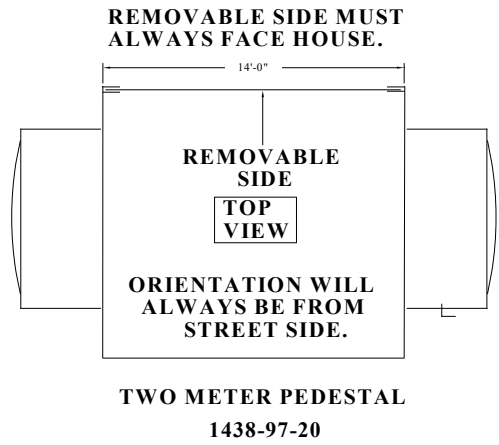
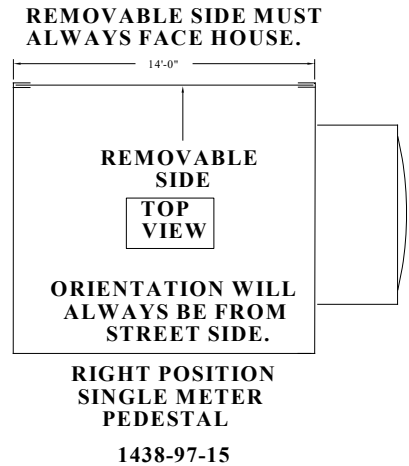
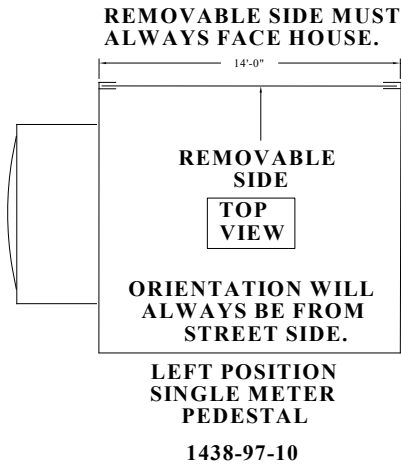
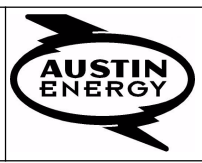

- NOTE:**
1. THERE SHALL BE A THREE FOOT (3') WORKING CLEARANCE ON ALL FOUR SIDES OF PEDESTAL PAD.
 2. REMOVABLE SIDE OF PEDESTAL SHALL ALWAYS FACE HOUSE.
 3. ORIENTATION SHALL DETERMINE "LEFT" AND/OR "RIGHT" SINGLE METER PEDESTALS, AND SHALL ALWAYS BE FROM THE STREET SIDE.

1438-97	CIVIL	PADS, CLEARANCES AND BARRIERS PEDESTAL ASSEMBLIES POSITIONING	
Sheet 3 of 3			
Rev: 08/01/20			

ID	PART NUM	PART DESC	QTY		CU-REF
6	000008395	BOLT HEX HEAD ZINC G5CT 1/2 X 1-1/2	2	EA	14389730
7	000008494	WASHER ROUND HOT DIP GALV 1/2 INCH	2	EA	14389730
8	000008499	WASHER SQ HOT DIP GALV 2-1/4 IN X 2-1/4 IN X 3/16 IN	2	EA	14389730
4	0000017302	CLAMP GROUND VISE TYPE FOR 5/8 GROUND ROD CAST BRONZE	1	EA	14389730
2	0000018284	CONNECTOR 4 COND 350MCM TO #12 600V DIRECT BURY INSUL	3	EA	14389730
1	0000018419	PEDESTAL THREE METER ASSEMBLY	1	EA	14389730

PED3MTRASSY

14389730

PEDESTAL THREE METER ASSEMBLY

ID	PART NUM	PART DESC	QTY		CU-REF
3	0000004533	CABLE BARE STRD COP TINNED SOFT # 2 2400/FT	6	EA	14389730
5	000008326	ANCHOR DROP IN 1/2 IN	2	EA	14389730
6	000008395	BOLT HEX HEAD ZINC G5CT 1/2 X 1-1/2	2	EA	14389730
7	000008494	WASHER ROUND HOT DIP GALV 1/2 INCH	2	EA	14389730
8	000008499	WASHER SQ HOT DIP GALV 2-1/4 IN X 2-1/4 IN X 3/16 IN	2	EA	14389730
4	0000017302	CLAMP GROUND VISE TYPE FOR 5/8 GROUND ROD CAST BRONZE	1	EA	14389730
2	0000018284	CONNECTOR 4 COND 350MCM TO #12 600V DIRECT BURY INSUL	3	EA	14389730
1	0000018419	PEDESTAL THREE METER ASSEMBLY	1	EA	14389730

FOR DETAILS	SEE PAGE
BARRIER POSTS AND CLEARANCE	1438- 10
STRUCTURE GROUNDING	1488- 10 AND 1488- 20
EQUIPMENT ANCHORING HARDWARE	1502- 02